

HILTI

DX 460

Operating instructions

en

Mode d'emploi

fr

操作説明書

zh

取扱説明書

ja

사용설명서

ko

دليل الاستعمال

ar

操作说明书

cn

Пайдалану бойынша басшылық

kk



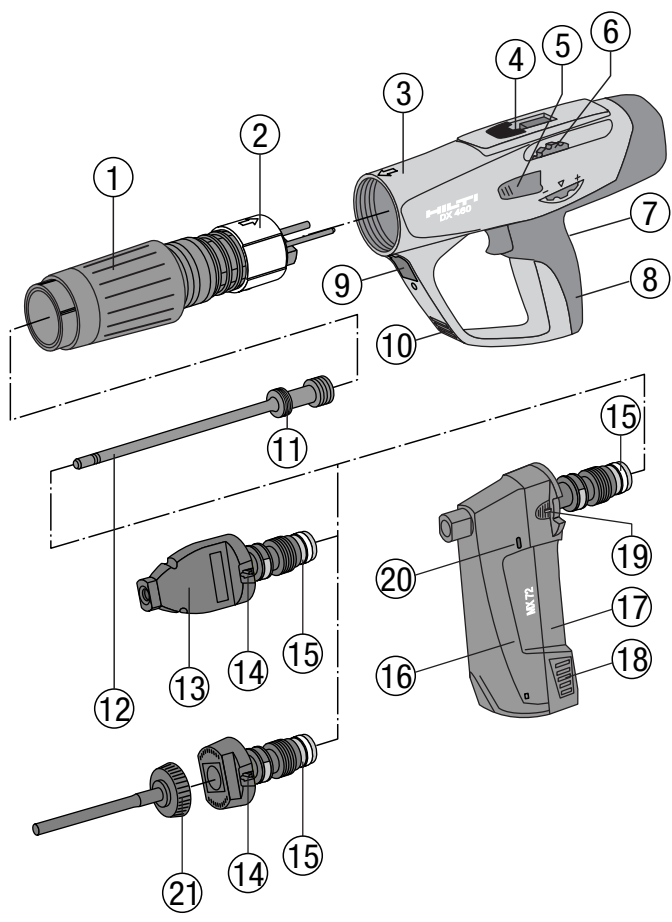

6.2

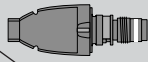

	X-MX 72 ¹⁾	X-460-F8	X-460-F8N15	X-460-F8N10	X-460-F8CW	X-460-F8S12	X-460-F8SS	X-460-F10	X-460-F10SS	X-460-F1E-L
X-U	S/W	S/W	S/W	S/W	S					
X-C	S/W	S/W	S/W	S/W	S					
X-S	S	S	S	S	S					
X-CT	S/W	S/W	S/W	S/W						
X-CR		S	S	S						
X-CP / X-CF		S								
DS								10		
X-FS / X-SW	S/W	S/W								
X-IE / XI-FV										IE
X-HS / X-HS-W	S	S	S	S	S					
X-CC	S	S	S	S	S					
X-CW					S					
X-(D)FB / X-EMTC	S	S	S	S	S					
X-ECH / X-EKB	S	S			S					
X-M6 / W6 ... P8		S					S			
X-M8 / W8 ... P8							S			
X-M10 / W10 ... P10								10	10	
X-DNH, DKH ²⁾		S								
X-M6H, X-M8H ²⁾		K								

- S = X-460-P8
 W = X-460-P8W
 10 = X-460-P10
 IE = X-460-PIE-L
 K = X-460-PKwik

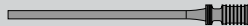

- en** 1) MX collated nail required
 2) Pre-drilling required for DX-Kwik fasteners

- ar** 1) بالنسبة للمسامير المخرنة ¹⁾
 2) الثقب الأولي ضروري لعنصر ²⁾
 DX-Kwik التثبيت

- fr** 1) pour clous en bande MX
 2) Pré-perçage requis pour éléments de fixation DX-Kwik

- cn** 1) 需要 MX 纸排钉
 2) 需针对 DX-Kwik 固定钉预先钻孔

- zh** 1) 需要MX纸排钉
 2) 需针对DX-Kwik固定钉预先钻孔

- kk** 1) MX қорабына арналған шеге
 2) DX-Kwik бекіткіші үшін алдын ала бұрғылау қажет

- ja** 1) MX 連発ネイルが必要
 2) DX-Kwik ファスナーには予備穿孔が必要

- ko** 1) MX 타정기용 못 필요
 2) DX-Kwik 패스너를 위해 사전 드릴링 필요

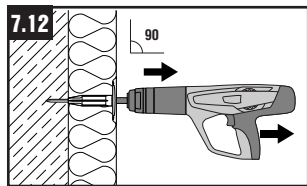
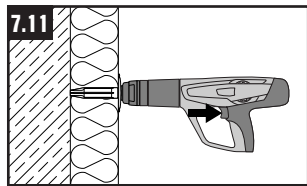
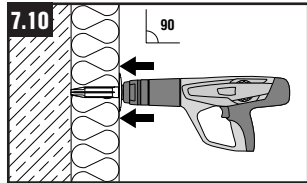
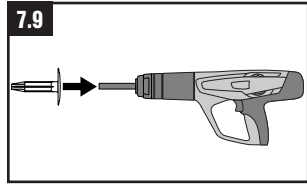
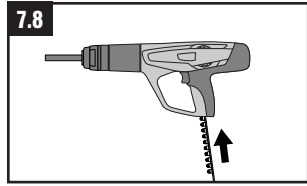
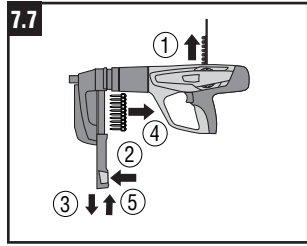
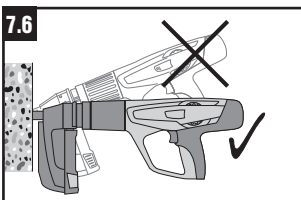
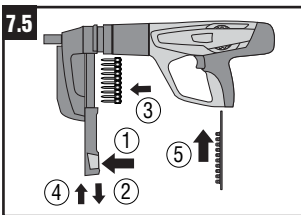
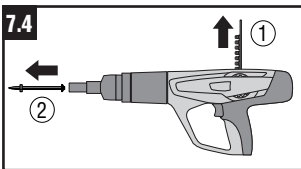
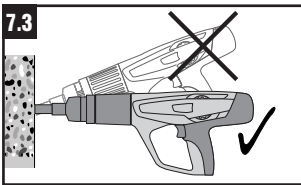
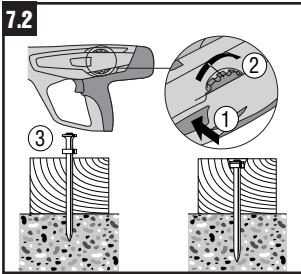
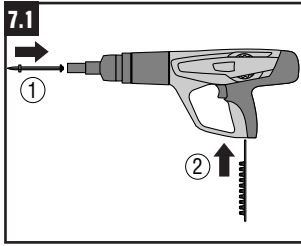
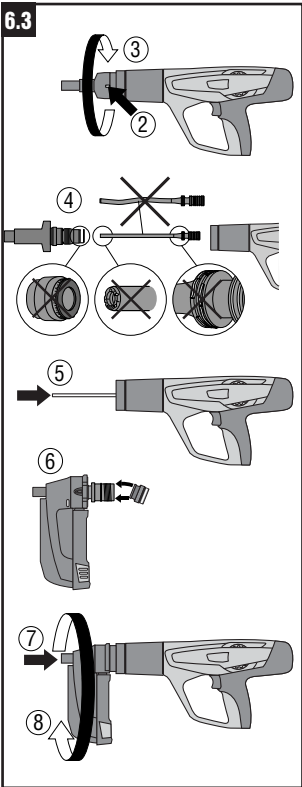
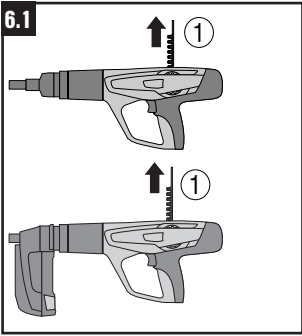

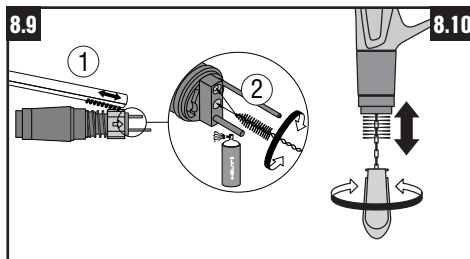
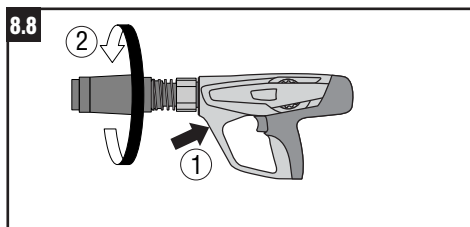
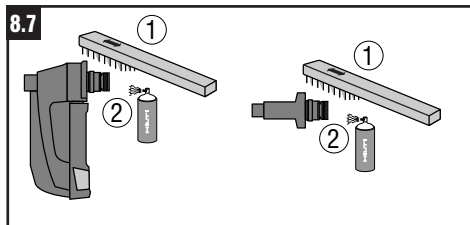
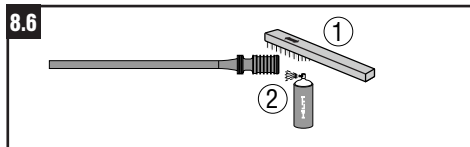
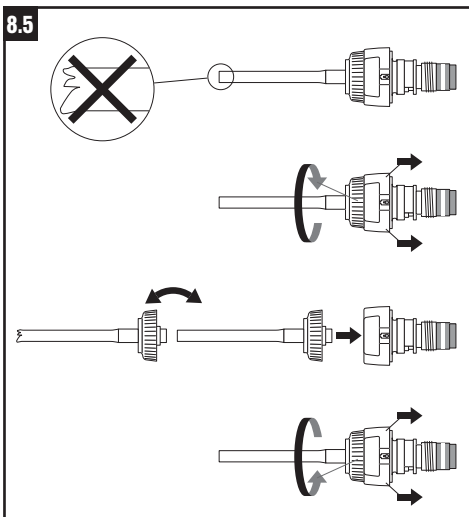
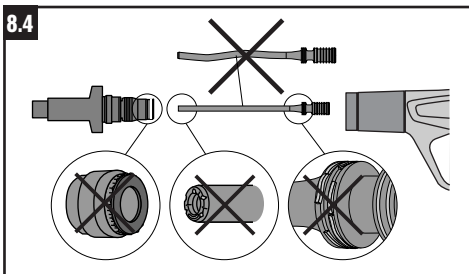
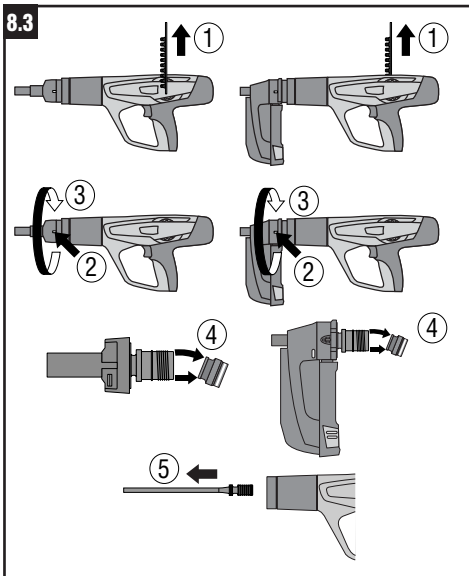

8.10

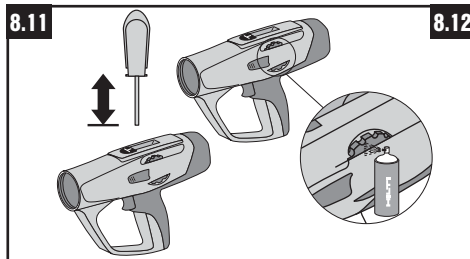

8.12

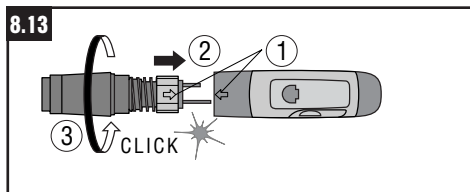

8.14

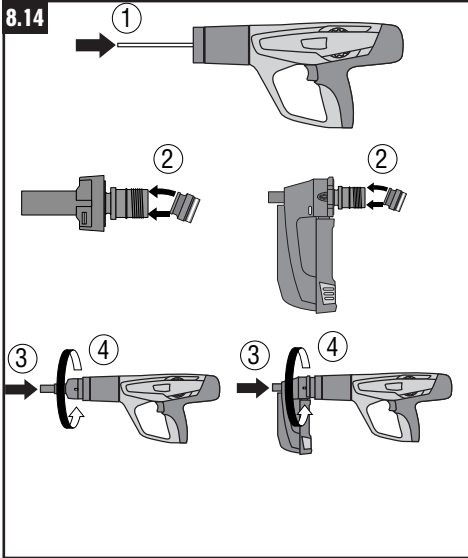

9.1

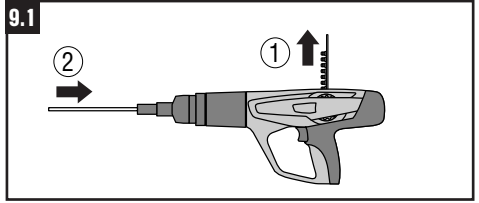

ORIGINAL OPERATING INSTRUCTIONS

DX 460 powder-actuated tool

It is essential that the operating instructions are read before the tool is operated for the first time.

Always keep these operating instructions together with the tool.

Ensure that the operating instructions are with the tool when it is given to other persons.

Description of main parts 1

- ① Exhaust gas piston return unit
- ② Guide sleeve
- ③ Housing
- ④ Cartridge guideway
- ⑤ Power regulation wheel release button
- ⑥ Power regulation wheel
- ⑦ Trigger
- ⑧ Grip
- ⑨ Piston return unit release button
- ⑩ Ventilation slots
- ⑪ Piston rings
- ⑫ Piston *
- ⑬ Fastener guide *
- ⑭ Fastener guide release button
- ⑮ Buffer *
- ⑯ Magazine *
- ⑰ Magazine cover
- ⑱ Magazine cover release button
- ⑲ Magazine release button
- ⑳ Load status indicator
- ㉑ Replaceable fastener guide nosepiece *

* These parts may be replaced by the user/operator.

Contents	Page
1. Safety precautions	1
2. General information	3
3. Description	3
4. Accessories	4
5. Technical data	6
6. Before use	6
7. Operation	7
8. Care and maintenance	9
9. Troubleshooting	11
10. Disposal	16
11. Manufacturer's warranty – DX tools	16
12. EC declaration of conformity (original)	17
13. CIP approval mark	17
14. Health and safety of the user	18

1. Safety precautions

1.1 Basic safety instructions

In addition to the safety precautions listed in the individual sections of these operating instructions, the following points must be strictly observed at all times.

1.2 Only use Hilti cartridges or cartridges of equivalent quality

The use of cartridges of inferior quality in Hilti tools may lead to build-up of unburned powder, which may explode and cause severe injuries to operators and bystanders. At a minimum, cartridges must either:

- a) Be confirmed by their supplier to have been successfully tested in accordance with EU standard EN 16264

NOTE:

- All Hilti cartridges for powder-actuated tools have been tested successfully in accordance with EN 16264.
- The tests defined in the EN 16264 standard are system tests carried out by the certification authority using specific combinations of cartridges and tools. The tool designation, the name of the certification authority and the system test number are printed on the cartridge packaging.

or

- b) Carry the CE conformity mark (mandatory in the EU as of July 2013).

See packaging sample at:
www.hilti.com/dx-cartridges

1.3 Use as intended

The tool is designed for professional use in fastening applications in construction where nails, threaded studs and composite fasteners are driven into concrete, steel and sand-lime block masonry.



1.4 Improper use

- Manipulation or modification of the tool is not permissible.
- Do not operate the tool in an explosive or flammable atmosphere, unless the tool is specially approved for such use.
- To avoid the risk of injury, use only original Hilti fasteners, cartridges, accessories and spare parts or those of equivalent quality.
- Observe the information printed in the operating instructions concerning operation, care and maintenance.

en

- Never point the tool at yourself or any bystander.
- Never press the muzzle of the tool against your hand or other part of your body.
- Do not drive nails into excessively hard or brittle materials such as glass, marble, plastic, bronze, brass, copper, natural rock, insulation material, hollow brick, glazed tile, thin-gauge sheet metal (< 4 mm), grey cast iron, spheroidal cast iron and gas concrete.

1.5 Technology

- This tool is designed with the latest available technology.
- The tool and its ancillary equipment may present hazards when used incorrectly by untrained personnel or not as directed.



1.6 Making the workplace safe

- Ensure that the workplace is well lit.
- Objects which could cause injury should be removed from the working area.
- Operate the tool only in well-ventilated working areas.
- The tool is for hand-held use only.
- Avoid unfavorable body positions. Work from a secure stance and stay in balance at all times
- Keep other persons, children in particular, outside the working area.
- Before using the tool, make sure that no one is standing behind or below the point where fasteners are to be driven.
- Keep the grip dry, clean and free from oil and grease.



1.7 General safety precautions

- Operate the tool only as directed and only when it is in faultless condition.
- Use the stabiliser/splinter guard when the application permits.
- If a cartridge misfires or fails to ignite, proceed as follows:
 1. Keep the tool pressed against the working surface for 30 seconds.
 2. If the cartridge still fails to fire, withdraw the tool from the working surface, taking care that it is not pointed towards your body or bystanders.
 3. Manually advance the cartridge strip one cartridge. Use up the remaining cartridges on the strip. Remove the used cartridge strip and dispose of it in such a way that it can be neither reused nor misused.
- If 2–3 cartridge firing with reduced driving power occur in succession (without clearly audible noise of the cartridge firing and the fastener being driven with significantly less power), proceed as follows:
 1. Stop using the tool immediately.
 2. Unload and disassemble the tool (see 8.3).

3. Check that the correct combination of fastener guide, piston and fastener are used (see 6.2).
4. Check the buffer, piston and fastener guide / magazine for wear and replace the parts if necessary (See 6.3 and 8.4. X-IE see 8.5).
5. Clean the tool.
6. Do not continue to use the tool if the problem persists after carrying out the steps described above. Have the tool checked and repaired if necessary at a Hilti repair center.
 - Never attempt to pry a cartridge from the magazine strip or the tool.
 - Keep the arms flexed when the tool is fired (do not straighten the arms).
 - Never leave the loaded tool unattended.
 - Always unload the tool before beginning cleaning, servicing or changing parts and before storage.
 - Unused cartridges and tools not presently in use must be stored in a place where they are not exposed to humidity or excessive heat. The tool should be transported and stored in a toolbox that can be locked or secured to prevent use by unauthorized persons.



1.8 Temperature

- Do not disassemble the tool while it is hot.
- Never exceed the recommended maximum fastener driving rate (number of fastenings per hour). The tool may otherwise overheat.
- Should the plastic cartridge strip begin to melt, stop using the tool immediately and allow it to cool down.

1.9 Requirements to be met by users

- The tool is intended for professional use.
- The tool may be operated, serviced and repaired only by authorised, trained personnel. This personnel must be informed of any special hazards that may be encountered.
- Proceed carefully and do not use the tool if your full attention is not on the job.
- Stop working with the tool if you feel any pain or discomfort.

1.10 Personal protective equipment



- The operator and other persons in the immediate vicinity must always wear approved eye protection, a hard hat and suitable ear protection.

2. General information

2.1 Signal words and their meaning

WARNING

The word WARNING is used to draw attention to a potentially dangerous situation which could lead to severe personal injury or death.

CAUTION

The word CAUTION is used to draw attention to a potentially dangerous situation which could lead to minor personal injury or damage to the equipment or other property.

2.2 Pictograms

Warning signs



General warning



Warning: hot surface

Symbols



Read the operation instructions before use

Obligation signs



Wear eye protection



Wear a safety helmet



Wear ear protection

1 The numbers refer to the illustrations. The illustrations can be found on the fold-out cover pages. Keep these pages open while you read the operating instructions.

In these operating instructions, the designation “the tool” always refers to the DX 460 powder-actuated tool.

Location of identification data on the tool

The type designation and the serial number are printed on the type plate on the tool. Make a note of this information in your operating instructions and always refer to it when making an enquiry to your Hilti representative or service department.

Type: DX 460

Serial no.: _____

3. Description

The tool is designed for professional use in fastening applications where nails, threaded studs and composite fasteners are driven into concrete, steel and sand-lime block masonry.

The tool works on the well-proven piston principle and is therefore not related to high-velocity tools. The piston principle provides an optimum of working and fastening safety. The tool works with cartridges of 6.8/11 caliber.

The piston is returned to the starting position and the cartridges are fed to the firing chamber automatically by gas pressure from the fired cartridge. This permits fastenings to be made very quickly and economically with nails and threaded studs. The use of a nail magazine greatly increases the speed and convenience of fastening with the tool, above all when making large numbers of identical fastenings of all kinds.

As with all powder-actuated tools, the tool, magazine, fastener program and cartridge program form a “technical unit”. This means that optimal fastening with this system can only be assured if the fasteners and cartridges are specially manufactured for it, or products of equivalent quality, are used. The fastening and application recommendations given by Hilti are only applicable if these conditions are observed.

The tool features 5-way safety – for the safety of the operator and bystanders.

The piston principle

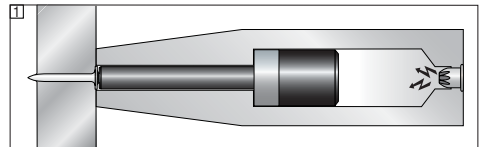

The energy from the propellant charge is transferred to a piston, the accelerated mass of which drives the fastener into the base material. As approximately 95 % of the kinetic energy is absorbed by the piston, the fastener is driven into the base material at much reduced velocity (less than 100 m/sec.) in a controlled manner. The driving process ends when the piston reaches the end of its travel. This makes dangerous through-shots virtually impossible when the tool is used correctly.

The drop-firing safety device **2** is the result of coupling the firing mechanism with the cocking movement. This is designed to prevent the Hilti DX tool from firing when it is dropped onto a hard surface, no matter at which angle the impact occurs.

The trigger safety device **3** ensures that the cartridge cannot be fired simply by pulling the trigger only. The tool can be fired only when pressed against the surface.

The contact pressure safety device [4] requires the tool to be pressed against a firm surface with a significant force. The tool can be fired only when pressed fully against the work surface in this way.

In addition, all Hilti DX tools are equipped with an unintentional firing safety device [5]. This prevents the tool from firing if the trigger is pulled and the tool then pressed against the work surface. The tool can be fired only when it is first pressed (1.) against the surface correctly and (2.) the trigger then pulled.

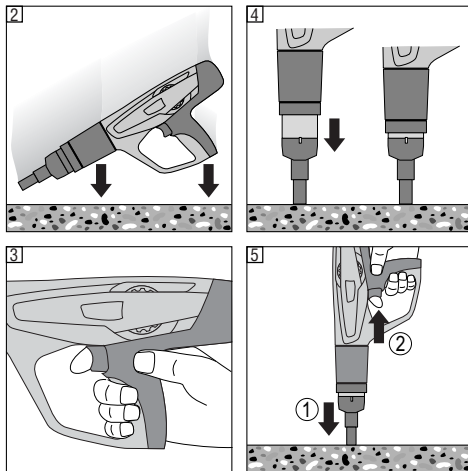

4. Cartridges, accessories and fasteners

Fasteners

Ordering designation	Application
X-U	High-strength nails for fastening to higher strength steel and concrete with a wide variety of applications.
X-C	Nails with differing application profile for a wide variety of fastenings
X-S	Standard nails for efficient fastening to steel
X-CT	Easily removable formwork nail for temporary fastenings
X-CR	Stainless-steel nails for fastenings in damp or corrosive surroundings
X-CP / X-CF	Special fastener for wooden structures on concrete
DS	High-performance nail for general fastening on concrete and steel
X-FS	The ideal fastener for positioning formwork
X-SW	Flexible washer fasteners for fastening insulating foils / sheeting to concrete and steel
X-IE / XI-FV	The ideal fastener for fastening insulation material to concrete, plastered solid masonry and steel
R 23 / R 36	Washers for Hilti nails: simple securing of joint seals, foils / sheeting and timber to concrete and steel using the X-460 WH23/36 washer holder
X-HS / X-HS-W	Suspension system with threaded connection
X-CC / X-CW	Clip for securing suspended fastening systems using wires
X-(D)FB / X-EMTC	Metal conduit clip for fastening conduits or cable ducts and insulated pipes (hot or cold) for plumbing and heating
X-EKB	Cable clasp for fastening electric cables flat on ceilings and walls
X-ECH	Bunched cable holder for fastening cables on ceilings and walls
X-ET	Fastener for plastic (PVC) electric cable trunking
X-(E)M/W/6/8 ... P8, X-M/W10 ... P10	Studs for bolted fastenings on concrete and steel
X-DNH / DKH, X-M6/8H	Approved fastening system for use on concrete, predrilling required

For further equipment contact your local Hilti organisation.

Magazine

MX 72 Magazine – For quick and convenient fastenings

Fastener guides

Ordering designation	Application
X-460-F8	Standard
X-460-F8N15	15 mm width for improved accessibility
X-460-F8N10	10 mm width for improved accessibility
X-460-FBCW	For driving X-CW fasteners
X-460-F8S12	Fastener guide for fasteners with a 12 mm steel washer – higher pull over values
X-460-F8SS	Spall stop for 8 mm studs – reduces spalling
X-460-F10	For 10 mm studs and nails
X-460-F10SS	Spall stop for 10 mm studs – reduces spalling
X-460-FIE-L	For driving XI-FV and X-IE insulation fasteners up to 140 mm.
X-460-FIE-XL	For driving XI-FV and X-IE insulation fasteners up to 200 mm.

Accessories

Ordering designation	Application
X-SGF8	Splinter guard for the X-460-F8 standard fastener guide
X-460-SGMX	Splinter guard for the X-460-MX72
X-460-STAB	For the X-460-F10 fastener guide
X-460-TIE-L	Replacement nosepiece for the X-460-FIE-L fastener guide (25–140 mm)
X-460-TIE-XL	Replacement nosepiece for the X-460-FIE-XL fastener guide (25–200 mm)
X-EF adaptor	X-EF adaptor for stabilizing the tool perpendicular to the work surface and for reducing concrete spalling when fastening the X-EKB and X-ECH (only with X-460-F8 fastener guide)
X-460-B	Rubber buffer – protects the fastener guide when the tool is used incorrectly
X-460-WH23/36	Washer holder – For fastening 23 and 36 mm steel washers with the magazine. The washer holder can be mounted on the magazine.
X-PT 460	Pole tool extension – Extension system for various ceiling application

Pistons

Ordering designation	Application
X-460-P8	Standard piston
X-460-P8W	Special piston with tapered tip for over-driving nails in wood (driving head beneath surface)
X-460-P10	10 mm piston – For fastening M 10 / W10 studs
X-460-PIE-L	Piston for driving X-IE insulation fasteners using the X-460-FIE-L fastener guide suitable for insulation thicknesses of 25–140 mm.
X-460-PIE-XL	Piston for driving X-IE insulation fasteners using the X-460-FIE-XL fastener guide suitable for insulation thicknesses of 25–200 mm
X-460-PKwik	Piston for driving approved threaded studs using the DX-Kwik technique (predrilling required)

Cartridges

Ordering designation	Colour code	Power level
6.8/11 M green	Green	Low
6.8/11 M yellow	Yellow	Medium
6.8/11 M red	Red	Heavy
6.8/11 M black	Black/purple	Extra heavy

Cleaning set

Hilti spray, flat brush, large round brush, small round brush, scraper, cleaning cloth.

5. Technical data

DX 460 tool

Weight	3.25 kg (7.16 lb), 3.51 kg (7.78 lb) with magazine
Tool length	458 mm (18.03"), 475 mm (18.7") with magazine
Nail length	Max. 72 mm (2 ⁷ / ₈ "
Recommended maximum fastening rate	700 per hour
Cartridges	6.8/11 M (27 cal. short) green, yellow, red, black
Power regulation	4 cartridge power levels, regulation wheel with locking function

MX 72 magazine

Weight	0.653 kg (1.44 lb)
Nail length	Max. 72 mm (2 ⁷ / ₈ "
Magazine capacity	Max. 13 nails

Right of technical changes reserved

en

6. Before use



6.1 Tool inspection

- Ensure that there is no cartridge strip in the tool. If there is a cartridge strip in the tool, remove it by hand from the tool.
- Check all external parts of the tool for damage at regular intervals and check that all controls operate properly. Do not operate the tool when parts are damaged or when the controls do not operate properly. If necessary, have the tool repaired at a Hilti service centre.
- Check the buffer and piston for wear (see "8. Care and maintenance").

6.2 Choosing the right fastener guide / piston / fastener combination

Use of the wrong combination may present a risk of injury. Damage to the tool may also result or fastening quality may be negatively affected (see table on last page of these instructions).

6.3 Conversion from single-fastener tool to magazine tool (changing the fastener guide)

1. Ensure that no cartridge strip or fastener is loaded in the tool. Remove the cartridge strip by pulling it upwards out of the tool and remove the fastener from the fastener guide / magazine.
2. Press the release button on the side of the fastener guide.
3. Unscrew the fastener guide.
4. Check the buffer and piston for wear (see "Care and maintenance").
5. Push the piston into the tool as far as it will go.
6. Press the buffer onto the magazine until it snaps into place.
7. Push the magazine firmly onto the piston return unit.
8. Screw the magazine onto the tool until it engages.

7. Operation



WARNING	
 	<ul style="list-style-type: none"> ■ The base material may splinter when a fastener is driven or fragments of the cartridge strip may fly off. ■ Flying fragments may injure parts of the body or the eyes. ■ Wear approved eye protection and a hard hat (users and bystanders).

CAUTION	
	<ul style="list-style-type: none"> ■ The nail or stud is driven by a cartridge being fired. ■ Excessive noise may damage the hearing. ■ Wear ear protection (users and bystanders).

WARNING	
 	<ul style="list-style-type: none"> ■ The tool could be made ready to fire if pressed against a part of the body (e.g. hand).. ■ This could cause a nail or piston to be driven into a part of the body. ■ Never press the muzzle of the tool against parts of the body.

WARNING	
 	<ul style="list-style-type: none"> ■ Under certain circumstances, the tool could be made ready to fire by pulling back the magazine, fastener guide or the fastener by hand. ■ When in the "ready to fire" state, a fastener or the piston could be driven into a part of the body. ■ For this reason, never pull back the magazine, fastener guide or fastener by hand.

Guidelines for optimum fastening quality

NOTE

These application recommendations must always be observed. For more specific information, refer to the Hilti Fastening Technology Manual, which is available from your local Hilti organisation.

en

Minimum requirements

Fastening on steel

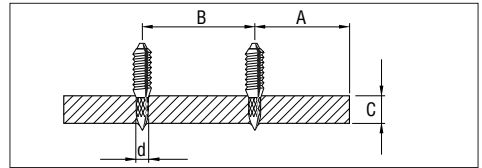

Steel

- A = min. edge distance = 15 mm ($\frac{3}{8}$ ")
- B = min. spacing = 20 mm ($\frac{3}{4}$ ")
- C = min. base material thickness = 4 mm ($\frac{3}{16}$ ")

Fastening on concrete

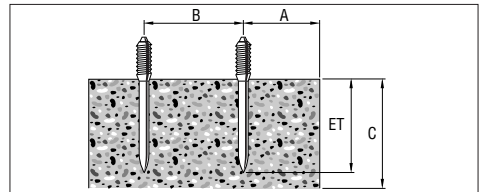

Concrete

- A = min. edge distance = 70 mm ($2\frac{7}{8}$ ")
- B = min. spacing = 80 mm ($3\frac{1}{8}$ ")
- C = min. base material thickness = 100 mm (4")

Nail lengths

(These are only examples, find specific information in the Hilti Fastening Technology Manual)

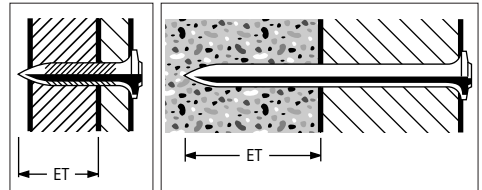

Fastening on steel:

Penetration depth (ET):
 12 ± 2 mm, ($\frac{1}{2} \pm \frac{1}{16}$ ")

Fastening on concrete

Penetration depth (ET):
 22 mm (27 max), ($\frac{7}{8}$ " (1" max)

X-IE fastener

(concrete, steel and other suitable materials – see 5.3)

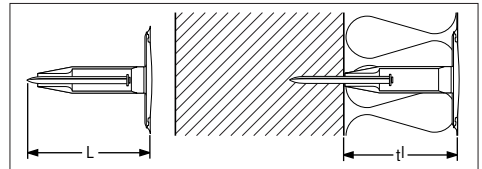

On all base materials, fastener length (L) corresponds to thickness of insulating material (tl).

7.1 Loading the single-fastener tool

1. Insert the fastener (head first) until the washer is held in the tool.
2. Load the cartridge strip (narrow end first) by inserting it into the bottom of the tool grip until flush. If the strip has been partly used, pull it through until a live cartridge is in the chamber. (The last visible number on the back of the cartridge strip indicates which cartridge is next to be fired.)

7.2 Adjusting the driving power

Select a cartridge power level and power setting to suit the application. If you cannot estimate this on the basis of previous experience, always begin with the lowest power.

1. Press the release button.
2. Turn the power regulation wheel to 1.
3. Drive a nail.
4. If the fastener doesn't penetrate deeply enough, increase the driving power by turning the power regulation wheel. Use a more powerful cartridge if necessary.

7.3 Fastening with the single-fastener tool

1. Press the tool firmly against the work surface at right angles.
2. Fire the tool by pulling the trigger.

WARNING

- Never attempt to drive a fastener in an existing hole except where recommended by Hilti, e.g. when using the DX Kwik system.
- Never attempt to redrive the same fastener.
- Never exceed the maximum fastener driving rate.

7.4 Unloading the single-fastener tool

Ensure that no cartridge strip or fastener is loaded in the tool. Remove the cartridge strip by pulling it upwards out of the tool and remove the fastener from the fastener guide.

7.5 Loading the magazine tool

1. Release the magazine cover by pressing the release button.
2. Pull the magazine cover down as far as it will go.
3. Load a new nail strip into the magazine.
4. Push the magazine cover up until it snaps closed.
5. Load the cartridge strip (narrow end first) by pushing it into the grip from below until flush. If the strip has been partly used, pull it through until an unused cartridge is in the chamber. (The last visible number on the back of the cartridge strip indicates which cartridge is next to be fired.)

When the indicator shows red, or partly red, there are 3 or less nails in the magazine. A strip of 10 nails may then be loaded.

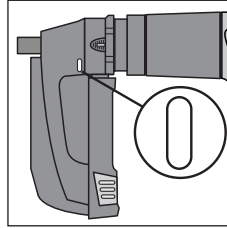

There are more than 3 nails in the magazine.

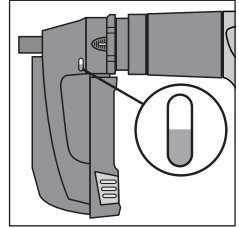

There are 3 or less nails in the magazine. A strip of 10 nails may be loaded.

WARNING

- All nails in the magazine must be of the same length.

7.6 Fastening with the magazine tool

1. Press the tool firmly against the work surface at right angles.
2. Fire the tool by pulling the trigger.

WARNING

- Never attempt to drive a fastener in an existing hole except where recommended by Hilti, e.g. when using the DX Kwik system.
- Never attempt to redrive the same fastener.
- Never exceed the maximum fastener driving rate.

7.7 Unloading the magazine tool

1. Ensure that there is no cartridge strip in the tool. If there is a cartridge strip in the tool, remove it by pulling it upwards out of the tool.
2. Release the magazine cover by pressing the release button.
3. Pull the magazine cover down as far as it will go.
4. Ensure that there is no nail strip in the magazine.
5. Push the magazine cover up until it snaps closed.

7.8

Load the cartridge strip (narrow end first) by inserting it into the bottom of the tool grip until flush. If the strip has been partly used, pull it through until a live cartridge is in the chamber. (The last visible number on the back of the cartridge strip indicates which cartridge is next to be fired.)

7.9 Using X-IE insulation fasteners

Push the X-IE fastener onto the nosepiece of the DX 460 IE as far as it will go.

7.10

Press the tool against the insulating material at right angles so that the X-IE is pushed through the insulating material and lies flush with its surface.

7.11

Drive the fastener by pulling the trigger.

7.12

Pull the tool out of the X-IE fastener at right angles.

8. Care and maintenance

When this type of tool is used under normal operating conditions, dirt and residues build up inside the tool and functionally relevant parts are also subject to wear. Regular inspections and maintenance are thus essential in order to ensure reliable operation. We recommend that the tool is cleaned and the piston and piston brake are checked at least weekly when the tool is subjected to intensive use, and at the latest after driving 10,000 fasteners.

8.1 Care of the tool

The outer casing of the tool is manufactured from impact-resistant plastic. The grip comprises a synthetic rubber section.

The ventilation slots must be unobstructed and kept clean at all times. Do not permit foreign objects to enter the interior of the tool. Use a slightly damp cloth to clean the outside of the tool at regular intervals. Do not use a spray or steam-cleaning system for cleaning.

8.2 Maintenance

Check all external parts of the tool for damage at regular intervals and check that all controls operate properly. Do not operate the tool when parts are damaged or when the controls do not operate properly. If necessary, have the tool repaired at a Hilti service centre.

CAUTION	
	<ul style="list-style-type: none">■ The tool can get hot while operating.■ You could burn your hands.■ Do not disassemble the tool while it is hot. Let the tool cool down.

Servicing the tool

The tool should be serviced if:

1. Cartridges misfire
2. Fastener driving power is inconsistent
3. If you notice that:
 - contact pressure increases,
 - trigger force increases,
 - power regulation is difficult to adjust (stiff),
 - the cartridge strip is difficult to remove.

CAUTION while cleaning the tool:

- Never use grease for maintenance/lubrication of tool parts. This may strongly affect the functionality of the tool. Use only Hilti spray or such of equivalent quality.
- Dirt from DX tool contains substances that could be endangering your health.
 - Do not breath in the dust from cleaning
 - Keep dust away from food
 - Wash your hands after cleaning the tool

8.3 Disassemble the tool

1. Ensure that no cartridge strip or fastener is loaded in

the tool. Remove the cartridge strip by pulling it upwards out of the tool and remove the fastener from the fastener guide.

2. Press the release button located at the side of the fastener guide.
3. Unscrew the fastener guide / magazine.
4. Remove the buffer by bending it away from the fastener guide / magazine.
5. Remove the piston.

8.4 Check the buffer and piston for wear

Replace the buffer if:

- the metal ring is loose or broken,
- the buffer no longer holds on the fastener guide,
- excessive, uneven wear beneath the metal ring is noticed.

Replace the piston if:

- it is broken,
- the tip is heavily worn (i.e. a 90° segment is chipped off),
- piston rings are broken or missing,
- it is bent (check by rolling on an even surface).

CAUTION

Do not use worn pistons. Do not modify or grind pistons.

8.5 Check the fastener guide for wear

The nosepiece of the X-460-FIE and X-460-FIE-L fastener guides should be replaced if the tubular section is damaged (e.g. bent, widened or cracked). For instructions on replacing the nosepiece, please refer to sections 6.3 and 8.5.

1. Ensure that no cartridge strip or fastener is loaded in the tool. Remove the cartridge strip by pulling it upwards out of the tool and remove the fastener from the fastener guide.
2. Press the release button on the side of the fastener guide.
3. Unscrew the fastener guide.
4. Check the buffer and piston for wear (see care and maintenance instructions).
5. Pull the moveable ring downwards and unscrew and remove the clamping nut.
6. Replace the fastener guide nosepiece.
7. Pull the moveable ring downwards and screw on the clamping nut.
8. Push the piston into the tool as far as it will go.
9. Press the buffer onto the fastener guide until it engages.
10. Push the fastener guide firmly onto the exhaust gas piston return unit.
11. Screw the fastener guide onto the tool until it engages.

8.6 Clean the piston rings

1. Clean the piston rings with the flat brush until they move freely..
2. Spray the piston rings lightly with Hilti spray.

8.7 Clean the threaded section of the fastener guide/magazine

1. Clean the thread with the flat brush.
2. Spray the thread lightly with Hilti spray.

8.8 Disassemble the piston return unit

1. Press the release button at the gripping part.
2. Unscrew the piston return unit.

8.9 Clean the piston return unit

1. Clean the spring with the flat brush.
2. Clean the front end with the flat brush.
3. Use the small round brush to clean the two holes at the end face.
4. Spray the piston return unit lightly with Hilti spray.

8.10 Clean inside the housing

1. Use the large round brush to clean inside the housing.
2. Spray the inside of the housing lightly with Hilti spray.

8.11 Clean the cartridge strip guideway

Use the scraper provided to clean the right and left cartridge strip guideways. The rubber cover must be lifted slightly to facilitate cleaning of the guideway.

8.12 Spray the power regulation wheel lightly with Hilti spray**8.13 Fit the piston return unit**

1. Bring the arrows on the housing and on the exhaust gas piston return unit into alignment.
2. Push the piston return unit into the housing as far as it will go.
3. Screw the piston return unit onto the tool until it engages.

8.14 Assemble the tool

1. Push the piston into the tool as far as it will go.
2. Press the buffer onto the fastener guide / magazine until it snaps into place.
3. Press the fastener guide / magazine firmly onto the piston return unit.
4. Screw the fastener guide / magazine onto the tool until it engages.

8.15 Checking the tool following care and maintenance

After carrying out care and maintenance on the tool, check that all protective and safety devices are fitted and that they function correctly.

NOTE

- The use of lubricants other than Hilti spray could damage rubber parts, especially the buffer.

9. Troubleshooting

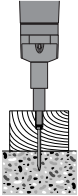
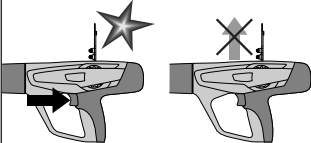
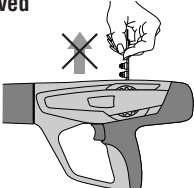
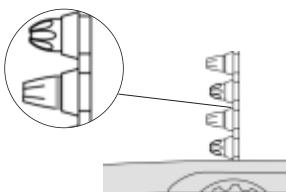
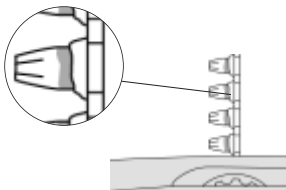
Fault	Cause	Possible remedies
<p>Piston is stuck in the base material</p> 	<ul style="list-style-type: none"> ■ Fastener too short ■ Fastener without washer ■ Driving power too high 	<ul style="list-style-type: none"> ■ Remove the cartridge strip and push the piston all the way back (see 8.3-8.14) ■ Use longer fastener ■ Use fastener with washer for wood applications ■ Reduce power setting <ul style="list-style-type: none"> • Power regulation • Lower cartridge power level
<p>Cartridge not transported</p> 	<ul style="list-style-type: none"> ■ Damaged cartridge strip ■ Carbon build up ■ Tool damaged 	<ul style="list-style-type: none"> ■ Change cartridge strip ■ Clean the cartridge strip guide-way (see 8.11) <p>If the problem persists:</p> <ul style="list-style-type: none"> ■ Contact Hilti Repair Centre
<p>Cartridge strip cannot be removed</p> 	<ul style="list-style-type: none"> ■ Tool overheated because of high setting rate ■ Tool damaged <p>WARNING Never attempt to pry a cartridge from the magazine strip or tool.</p>	<ul style="list-style-type: none"> ■ Let the tool cool down and then carefully try to remove the cartridge strip <p>If not possible:</p> <ul style="list-style-type: none"> ■ Contact Hilti Repair Centre
<p>Cartridge cannot be fired</p> 	<ul style="list-style-type: none"> ■ Bad cartridge ■ Carbon build-up <p>WARNING Never attempt to pry a cartridge from the magazine strip or the tool.</p>	<ul style="list-style-type: none"> ■ Manually advance the cartridge strip one cartridge If the problem occurs more often: Clean the tool (see 8.3–8.14) <p>If the problem persists:</p> <ul style="list-style-type: none"> ■ Contact Hilti Repair Centre
<p>Cartridge strip melts</p> 	<ul style="list-style-type: none"> ■ Tool is compressed too long while fastening. ■ Fastening frequency is too high 	<ul style="list-style-type: none"> ■ Compress the tool less long while fastening. ■ Remove the cartridge strip ■ Disassemble the tool (see 8.3) for fast cooling and to avoid possible damage <p>If the tool cannot be disassembled:</p> <ul style="list-style-type: none"> ■ Contact Hilti Repair Centre

en

Fault

Cartridge falls out of the cartridge strip

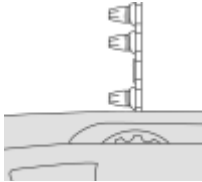

Cause

■ Fastening frequency is too high

WARNING

Never attempt to pry a cartridge from the magazine strip or tool.

Possible remedies

- Immediately discontinue using the tool and let it cool down
- Remove cartridge strip
- Let the tool cool down.
- Clean the tool and remove loose cartridge.

If it is impossible to disassemble the tool:

■ Contact Hilti Repair Centre

The operator notices:

- increased contact pressure
- increased trigger force
- power regulation stiff to adjust
- cartridge strip is difficult to remove

■ Carbon build-up

- Clean the tool (see 8.3–8.14)
- Check that the correct cartridges are used (see 1.2) and that they are in faultless condition.

Varying depths of penetration

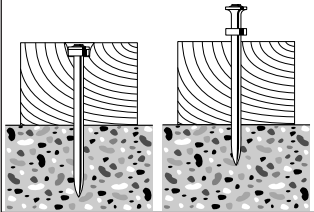

■ Incorrect piston position

■ Carbon build-up

- Remove the cartridge strip and clean the tool (see 8.4).
- Check the piston and buffer and replace these parts if necessary (see 8.4).

If the problem persists:

■ Contact Hilti Repair Centre

Cartridge with reduced driving power

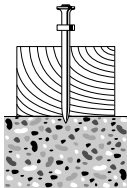

■ Incorrect piston position

■ Bad cartridge

- Remove the cartridge strip and clean the tool (see 8.3-8.14).
- Check that the correct cartridges are used (see 1.2) and that they are in faultless condition.

If the problem persists:

■ Contact Hilti Repair Centre

Piston is stuck in the piston return unit and cannot be removed

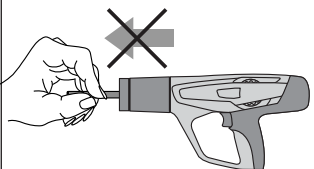

- Damaged piston
- Buffer debris inside the piston return unit

■ Damaged buffer

■ Carbon build-up

- Remove the cartridge strip and clean the tool (see 8.3-8.14).
- Check the piston and buffer and replace these parts if necessary (see 8.4).

If the problem persists:

■ Contact Hilti Repair Centre

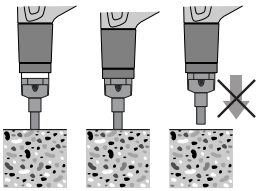
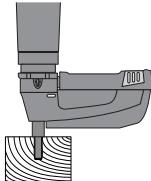
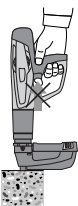
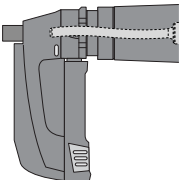
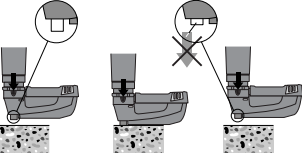
Fault	Cause	Possible remedies
<p>Piston return unit is stuck</p> 	<ul style="list-style-type: none"> Carbon build-up 	<ul style="list-style-type: none"> Manually pull the front part of the piston return unit out of the tool Check that the correct cartridges are used (see 1.2) and that they are in faultless condition. Clean the tool (see 8.3–8.14) <p>If the problem persists:</p> <ul style="list-style-type: none"> Contact Hilti Repair Centre
<p>The tool fires but no nail is driven</p> 	<ul style="list-style-type: none"> Incorrect piston position 	<ul style="list-style-type: none"> Remove the cartridge strip and clean the tool (see 8.3-8.14). Check that the correct cartridges are used (see 1.2) and that they are in faultless condition. <p>If the problem persists:</p> <ul style="list-style-type: none"> Contact Hilti Repair Centre
<p>Trigger cannot be pulled</p> 	<ul style="list-style-type: none"> Tool not fully compressed Safety mechanism activated because: <ul style="list-style-type: none"> Magazine not loaded Plastic debris inside the magazine Incorrect piston position Nail incorrectly positioned in magazine 	<ul style="list-style-type: none"> Release the tool and fully compress it again Load fastener strip Open magazine, remove fastener strip and plastic debris Clean the tool (see 8.3-8.14). <p>If the problem persists:</p> <ul style="list-style-type: none"> Contact Hilti Repair Centre
<p>Piston stuck in magazine fastener guide</p> 	<ul style="list-style-type: none"> Piston and/or buffer damaged Plastic debris inside the magazine Excess power when fastening on steel Tool fired with high power without fastener in place 	<ul style="list-style-type: none"> Unscrew the magazine Check buffer and piston and replace if necessary (see 8.4) Open magazine, remove fastener strip and plastic debris
<p>Magazine fastener guide is stuck</p> 	<ul style="list-style-type: none"> Fastener guide damaged 	<ul style="list-style-type: none"> Change magazine

Fault

Cause

MPossible remedies

Fastener penetrates too deeply

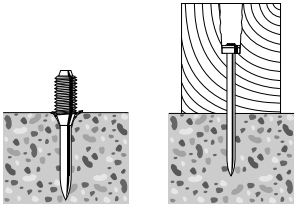

- Fastener too short
- Driving power too high

- Use longer fastener
- Reduce power setting
- Use lighter cartridge

Fastener does not penetrate deeply enough

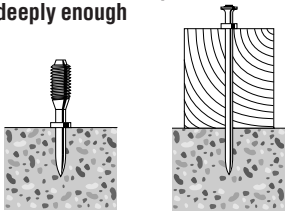

- Fastener too long
- Driving power too low

- Use shorter fastener
- Increase power setting
- Use heavier cartridge

Nail bends

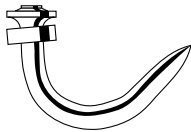

- Hard and/or large aggregate in concrete
- Rebar close to surface of concrete
- Hard surface (steel)

- Use shorter nail
- Use a nail with a higher application limit
- Use DX-Kwik (predrill)
- Change to single fasteners

Incorrect X-IE fastenings

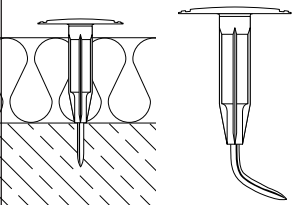

- Wrong type of fastener used
- Fastener driving power set incorrectly
- Concrete contains hard and/or large aggregates
- Rebar located just beneath the surface
- Hard surface

- Use a fastener with a length suitable for the insulation material to be fastened
- Adjust the fastener driving power
- Use a more powerful cartridge

Base material is spalling

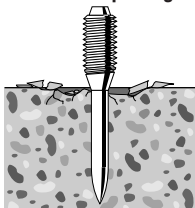

- High strength concrete
- Hard and/or large aggregate in concrete
- Old concrete

- Stud application
Use spall stop:
X-SS....
- Nail application
Use shorter nail
Use DX-Kwik (predrill)

Fault

Cause

Possible remedies

Damaged nail head

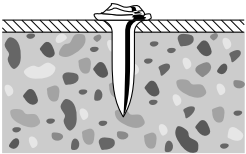

- Driving power too high
- Wrong piston used
- Damaged piston

- Reduce power setting
- Use lighter cartridge
- Check nail/piston combination
- Change piston

Nail does not penetrate surface



- Driving power too low
- Application limit exceeded (very hard surface)
- Unsuitable system

- Use a higher power setting or heavier cartridge
- Use stronger nail
- Change to single fasteners
- Switch to more powerful system e.g. DX 76 PTR

Nail does not hold in base material

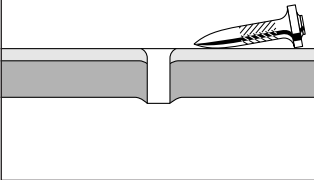

- Thin steel base material (4 to 5 mm steel)
- NOTE:**
Steel base material must be > 4 mm (see 5.3)

- Use a different power setting or different cartridge
- Use a nail suitable for thin steel base materials, e.g. X-EDNK 20 P8TH

Nail breaks

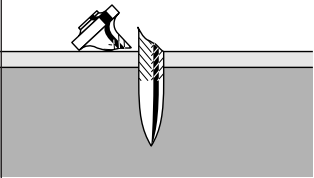

- Driving power too low
- Application limit exceeded (very hard surface)

- Try higher power setting or heavier cartridge
- Use shorter nail
- Use stronger nail

Nail head penetrates through material fastened (metal sheet)

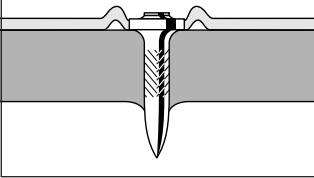

- Driving power too high

- Reduce power setting
- Use lighter cartridge
- Use nail with top hat
- Use nail with washer

Fault	Cause	Possible remedies
<p>Damaged nail head</p> 	<ul style="list-style-type: none"> ■ Driving power too high ■ Wrong piston used ■ Worn-out piston 	<ul style="list-style-type: none"> ■ Reduce power setting ■ Use lighter cartridge ■ Check nail/piston combination ■ Change piston

10. Disposal

Most of the materials from which Hilti power actuated tools are manufactured can be recycled. The materials must be correctly separated before they can be recycled. In many countries, Hilti has already made arrangements for taking back your old powder actuated tools for recycling. Please ask your Hilti customer service department or Hilti sales representative for further information.

Should you wish to return the power actuated tool yourself to a disposal facility for recycling, proceed as follows: Dismantle the tools as far as possible without the need for special tools.

Separate the individual parts as follows:

Part / assembly	Main material	Recycling
Toolbox	Plastic	Plastics recycling
Outer casing	Plastic / synthetic rubber	Plastics recycling
Screws, small parts	Steel	Scrap metal
Used cartridge strip	Plastic / steel	According to local regulations

11. Manufacturer's warranty – DX tools

Hilti warrants that the tool supplied is free of defects in material and workmanship. This warranty is valid so long as the tool is operated and handled correctly, cleaned and serviced properly and in accordance with the Hilti Operating Instructions, and the technical system is maintained. This means that only original Hilti consumables, components and spare parts, or other products of equivalent quality, may be used in the tool.

This warranty provides the free-of-charge repair or replacement of defective parts only over the entire lifespan of the tool. Parts requiring repair or replacement as a result of normal wear and tear are not covered by this warranty.

Additional claims are excluded, unless stringent national rules prohibit such exclusion. In particular, Hilti is not obligated for direct, indirect, incidental or conse-

quential damages, losses or expenses in connection with, or by reason of, the use of, or inability to use the tool for any purpose. Implied warranties of merchantability or fitness for a particular purpose are specifically excluded.

For repair or replacement, send tool or related parts immediately upon discovery of the defect to the address of the local Hilti marketing organization provided.

This constitutes Hilti's entire obligation with regard to warranty and supersedes all prior or contemporaneous comments and oral or written agreements concerning warranties.

12. EC declaration of conformity (original)

Designation:	Powder-actuated tool
Type:	DX 460
Year of design:	2001

We declare, on our sole responsibility, that this product complies with the following directives and standards: 2006/42/EC, 2011/65/EU.

**Hilti Corporation, Feldkircherstrasse 100,
FL-9494 Schaan**



Norbert Wohlwend

Head of Quality & Processes Management
BU Direct Fastening
08/2012

Tassilo Deinzer

Head BU Measuring Systems
BU Measuring Systems
08/2012

Technical documentation filed at:

Hilti Entwicklungsgesellschaft mbH
Zulassung Elektrowerkzeuge
Hiltistrasse 6
86916 Kaufering
Deutschland

en

13. CIP approval mark

The following applies to C.I.P. member states outside the EU and EFTA judicial area:

The Hilti DX 460 has been system and type tested. As a result, the tool bears the square approval mark showing approval number S 812. Hilti thus guarantees compliance with the approved type.

Unacceptable defects or deficiencies, etc. determined during use of the tool must be reported to the person responsible at the approval authority (PTB, Braunschweig) and to the Office of the Permanent International Commission (C.I.P.) (Permanent International Commission, Avenue de la Renaissance 30, B-1000 Brussels, Belgium).

14. Health and safety of the user

Noise information

Powder-actuated tool

Type:	DX 460
Modell:	Serial production
Caliber:	6.8/11 black
Power setting:	2
Application:	Fastening 24 mm thick wood to concrete (C40) with X-U 47P8

Declared measured values of noise characteristics according to 2006/42/EC Machinery Directive in conjunction with E DIN EN 15895

Noise (power) level:	$L_{WA, 1s}^1$	105 dB(A)
Emission noise-pressure level in the work station:	$L_{pA, 1s}^2$	101 dB(A)
Peak sound pressure emission level:	$L_{pC, peak}^3$	133 dB(C)

Operation and set-up conditions:

Set-up and operation of the pin driver in accordance with E DIN EN 15895-1 in the semi-anechoic test room of Müller-BBM GmbH. The ambient conditions in the test room conform to DIN EN ISO 3745.

Testing procedure:

Enveloping surface method in anechoic room on reflective surface area in accordance with E DIN EN 15895, DIN EN ISO 3745 and DIN EN ISO 11201.

NOTE: The noise emissions measured and the associated measurement uncertainty represent the upper limit for the noise values to be expected during the measurements.

Variations in operating conditions may cause deviations from these emission values.

¹ ± 2 dB (A) / ² ± 2 dB (A) / ³ ± 2 dB (C)

Vibration

The declared total vibration value according to 2006/42/EC does not exceed 2.5 m/s².

Further information regarding the health and safety of the user can be found at the Hilti web site: www.hilti.com/hse



Hilti Corporation

LI-9494 Schaan

Tel.: +423 / 234 21 11

Fax: +423 / 234 29 65

www.hilti.com

Hilti = registered trademark of Hilti Corp., Schaan

W 2678 | 0613 | 10-Pos. 4 | 1

Printed in Liechtenstein © 2013

Right of technical and programme changes reserved S. E. & O.

371667 / A3



371667