

# HILTI

## DAG 500-D

**Operating instructions**

**en**

**Mode d'emploi**

**fr**

**Manual de instrucciones**

**es**

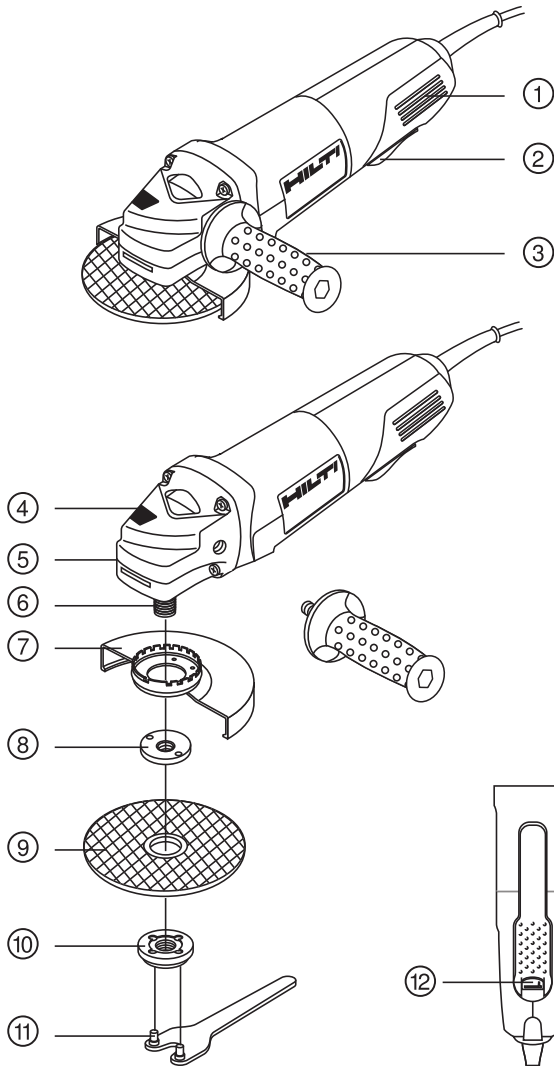

This Product is Certified  
Ce produit est homologué  
Producto homologado por  
Este producto está registrado



2

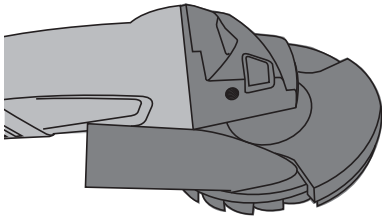

3

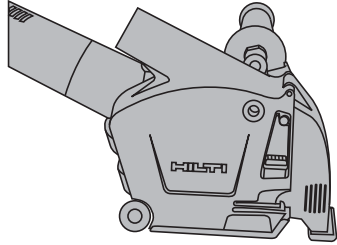

4

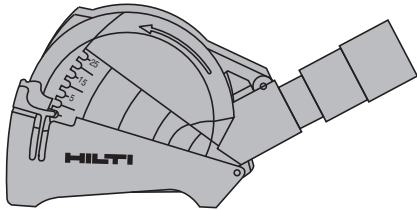

5

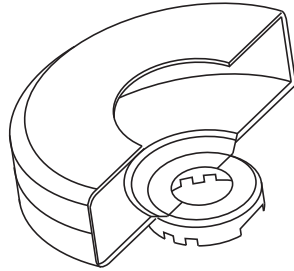

6

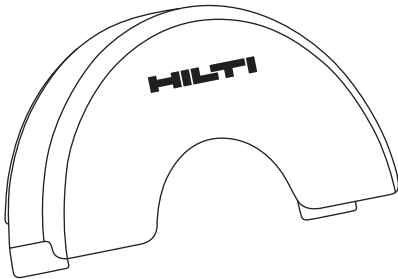

7

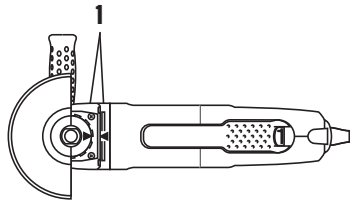

2

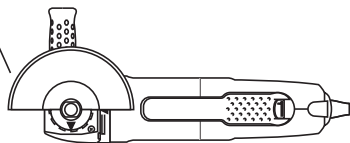

8

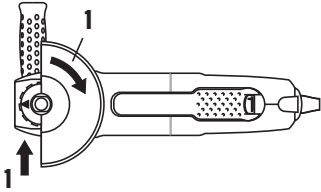

9

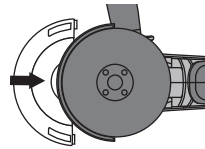
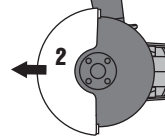
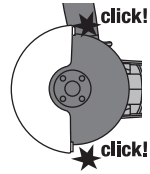
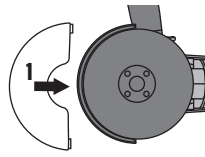

10

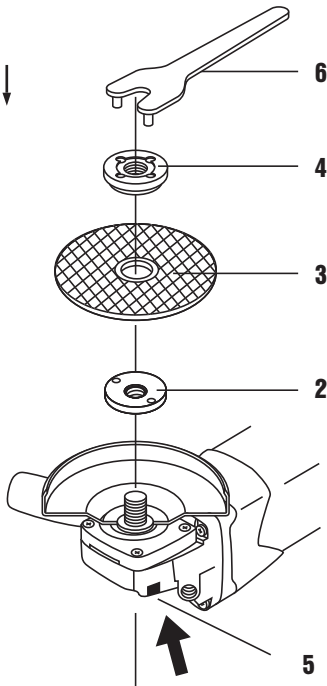

11

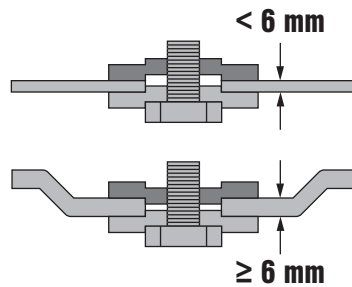

12

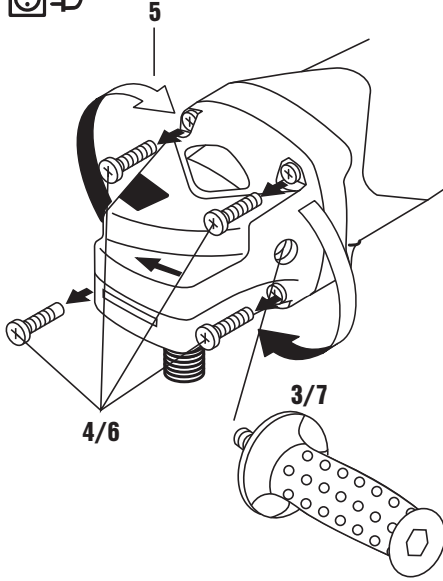
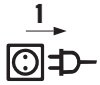

13

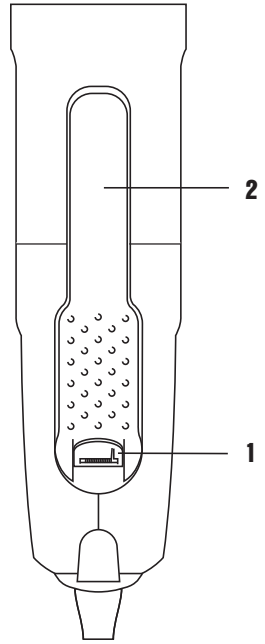

# ORIGINAL OPERATING INSTRUCTIONS

## DAG 500-D angle grinder

**It is essential that the operating instructions are read before the power tool is operated for the first time.**

**Always keep these operating instructions together with the power tool.**

**Ensure that the operating instructions are with the power tool when it is given to other persons.**

Contents	Page
1 General information	1
2 Description	2
3 Consumables	4
4 Technical data	5
5 Safety instructions	6
6 Before use	10
7 Operation	11
8 Care and maintenance	12
9 Troubleshooting	13
10 Disposal	13
11 Manufacturer's warranty - tools	13

**1** These numbers refer to the corresponding illustrations. The illustrations can be found on the fold-out cover pages. Keep these pages open while studying the operating instructions.

In these operating instructions, the designation "the power tool" always refers to the DAG 500-D angle grinder.

### Operating controls and components **1**

- ① Ventilation slots
- ② Hold-to-run switch
- ③ Side handle
- ④ Spindle lockbutton
- ⑤ Guard release button
- ⑥ Spindle
- ⑦ Guard
- ⑧ Clamping flange
- ⑨ Cutting disc / grinding disc (not supplied)
- ⑩ Clamping nuts
- ⑪ Wrench
- ⑫ Safety release

en

## 1 General information

### 1.1 Safety notices and their meaning

#### **DANGER**

Draws attention to imminent danger that will lead to serious bodily injury or fatality.

#### **WARNING**

Draws attention to a potentially dangerous situation that could lead to serious personal injury or fatality.

#### **CAUTION**

Draws attention to a potentially dangerous situation that could lead to slight personal injury or damage to the equipment or other property.

#### **NOTE**

Draws attention to an instruction or other useful information.

### 1.2 Explanation of the pictograms and other information

#### Warning signs



General warning



Warning: electricity



Warning: hot surface

## Obligation signs



Wear eye protection



Wear a hard hat



Wear ear protection



Wear protective gloves



Wear breathing protection

## Symbols



Read the operating instructions before use



Return waste material for recycling.

V

Volts

A

Amps



Alternating current

/min

Revolutions per minute

RPM

Revolutions per minute

n

Rated speed



Diameter



Double insulated

## Location of identification data on the power tool

The type designation, item number, year of manufacture and technical status can be found on the type identification plate on the machine or tool. The serial no. can be found on the underside of the motor housing. Make a note of this data in your operating instructions and always refer to it when making an enquiry to your Hilti representative or service department.

Type: \_\_\_\_\_

Serial no.: \_\_\_\_\_

## 2 Description

### 2.1 Use of the product as directed

The power tool is designed for cutting, grinding and brushing metal and mineral materials without use of water. Use of a guide carriage is mandatory for cutting stone.

The working environment may be as follows: construction site, workshop, renovation, conversion or new construction. The power tool may be operated only when connected to a power supply providing a voltage and frequency in compliance with the information given on its type identification plate.

Working with metals: Cutting, grinding, brushing.

Working with mineral materials: Cutting and slitting using the corresponding guard (DC-EX), grinding using the corresponding guard (DG-EX).

Use only discs (abrasive grinding discs, abrasive cutting discs, etc.) that are approved for use at a speed of at least 11000/min, with a maximum thickness of 1/4" (grinding discs) or 1/8" (cutting discs) and a diameter of max. 5".

Use only synthetic resin-bonded, fiber-reinforced grinding discs or cutting discs approved for use at a permissible peripheral speed of at least 80 m/sec.

The power tool may be used only for dry cutting or grinding.

When grinding stone, a vacuum cleaner equipped with a stone dust filter, e.g. a suitable Hilti vacuum cleaner, must be used.

Working on materials hazardous to the health (e.g. asbestos) is not permissible.

Nationally applicable industrial safety regulations must be observed.

Take the influences of the surrounding area into account. Do not use the power tool or appliance where there is a risk of fire or explosion.

To avoid the risk of injury, use only genuine Hilti accessories and insert tools.

Observe the information printed in the operating instructions concerning operation, care and maintenance.

The power tool is designed for professional use and may be operated, serviced and maintained only by trained, authorized personnel. This personnel must be informed of any special hazards that may be encountered. The power tool and its ancillary equipment may present hazards when used incorrectly by untrained personnel or when used not as directed.

Modification of the power tool or tampering with its parts is not permissible.

## 2.2 Switches

Hold-to-run switch

## 2.3 The items supplied in the cardboard box are:

- 1 Power tool with guard
- 1 Vibration-absorbing side handle
- 2 Nuts
- 1 Wrench
- 1 Operating instructions
- 1 Cardboard box

## 2.4 Using extension cords

Use only extension cords of a type approved for the application and with conductors of adequate cross section. The power tool may otherwise loose performance and the extension cord may overheat. Check the extension cord for damage at regular intervals. Replace damaged extension cords.

**Recommended minimum conductor cross section and max. cable lengths**

Conductor cross section	14 AWG	12 AWG
Mains voltage 110-120 V	75 ft	125 ft

Do not use extension cords with 16 AWG conductor cross section.

## 2.5 Using extension cords outdoors

When working outdoors, use only extension cords that are approved and correspondingly marked for this application.

## 2.6 Using a generator or transformer

This power tool may be powered by a generator or transformer when the following conditions are fulfilled: The unit must provide a power output in watts of at least twice the value printed on the type identification plate on the power tool. The operating voltage must remain within +5% and -15% of the rated voltage at all times, frequency must be in the 50 – 60 Hz range and never above 65 Hz, and the unit must be equipped with automatic voltage regulation and starting boost.

Never operate other power tools or appliances from the generator or transformer at the same time. Switching other power tools or appliances on and off may cause undervoltage and / or overvoltage peaks, resulting in damage to the power tool.

## 2.7 DG-EX 125/5" dust removal hood for grinding

The tool is suitable only for occasional use with diamond cup wheels for grinding mineral materials.

### CAUTION

Use of this guard for working on metal is not permissible.

### NOTE

It is recommended that a dust removal system consisting of matched components, i.e. dust removal hood and a suitable Hilti vacuum cleaner, are used for grinding mineral materials, such as concrete or stone. These serve to protect the operator and increase the life of the power tool and disc used.



### 2.8 DC-EX 125/5"-M dust removal hood with guide carriage for cutting and slitting 3

Cutting and slitting work on mineral materials may be carried out only when the power tool is equipped with a dust removal hood with guide carriage.

#### CAUTION

Use of this guard for working on metal is not permissible.

#### NOTE

It is recommended that a dust removal system consisting of matched components, i.e. dust removal hood and a suitable Hilti vacuum cleaner, are used for cutting and slitting mineral materials, such as concrete or stone. These serve to protect the operator and increase the life of the power tool and disc used.

### 2.9 DC-EX 125/5"-C compact dust removal hood for cutting 4

For cutting masonry and concrete.

#### CAUTION

Use of this guard for working on metal is not permissible.

#### NOTE

It is recommended that a dust removal system consisting of matched components, i.e. dust removal hood and a suitable Hilti vacuum cleaner, are used for cutting and slitting mineral materials, such as concrete or stone. These serve to protect the operator and increase the life of the power tool and disc used.

### 2.10 Guard with side cover 5

#### CAUTION

When grinding with straight grinding discs and cutting with cutting discs in metalworking applications, use the guard with cover plate.

### 2.11 Front cover for the disc guard 6

#### CAUTION

When grinding with straight grinding discs and cutting with cutting discs in metalworking applications, use the guard with front cover.

## 3 Consumables

Discs with a diameter of max. 5", designed for a speed of 11000/min and a peripheral speed of 80 m/sec, and with a maximum thickness of 1/4" (abrasive grinding discs) or 1/8" (abrasive cutting discs).

Discs / wire brushes	Application	Designation	Material
Abrasive cutting disc	Cutting, slitting	AC-D	metal
Diamond cutting disc	Cutting, slitting	DC-D	mineral
Abrasive grinding disc	Rough grinding	AG-D, AF-D, AN-D	metal
Diamond grinding disc	Rough grinding	DG-CW	mineral
Wire brushes	Wire brushes	3CS, 4CS, 3SS, 4SS	metal

#### Assignment of discs to the equipment used

Item	Equipment	AC-D	AG-D	AF-D	AN-D	DG-CW	DC-D	3CS/3SS/4CS/4SS
A	Guard	X	X	X	X	X	X	X
B	Front cover (in combination with A)	X	-	-	-	-	X	X
C	Guard with cover plate (optional for A, B)	X	-	-	-	-	X	-

Item	Equipment	AC-D	AG-D	AF-D	AN-D	DG-CW	DC-D	3CS/3SS/4CS/4SS
D	DG-EX 125/5" surface guard	-	-	-	-	X	-	-
E	DC-EX 125/5"-C compact guard (in combination with A)	-	-	-	-	-	X	-
F	DC-EX 125/5" M cutting guard for mineral materials	-	-	-	-	-	X	-
G	DC-EX SL cutting adapter (in combination with F)	-	-	-	-	-	X	-
H	Side handle	X	X	X	X	X	X	X
I	DC BG 125 hoop handle (optional for H)	X	X	X	X	X	X	X
K	Clamping nut (not for use with accessories with integrated thread)	X	X	X	X	X	X	-
L	Clamping flange (not for use with accessories with integrated thread)	X	X	X	X	X	X	-

#### 4 Technical data

Right of technical changes reserved.

Power tool	DAG 500-D
Rated voltage	120 V
Rated current input	8.5 A
Rated frequency	60 Hz
Rated speed	11,000/min
Cutting disc	Diameter Max. 5"
Dimensions (L x H x W) without hood	289 mm (11.38") x 103 mm (4.06") x 82 mm (11.4 in x 4.1 in x 3.2 in)
Weight (without accessories)	1.85 kg (4.1 lbs)

#### Information about the power tool and applications

Drive spindle thread (arbor size)	5/8"-11 UNC
Spindle length	6/8"
Protection class	Protection class II (double insulated)

## 5 Safety instructions

The safety rules in section 5.1 contain all general safety rules for power tools which, in accordance with the applicable standards, must be listed in the operating instructions. Accordingly, some of the rules listed may not be relevant to this tool.

### 5.1 General Power Tool Safety Warnings

- a)  **WARNING**  
**Read all safety warnings and instructions.** Failure to follow the warnings and instructions may result in electric shock, fire and/or serious injury. **Save all warnings and instructions for future reference.** The term “power tool” in the warnings refers to your mains-operated (corded) power tool or battery-operated (cordless) power tool.

#### 5.1.1 Work area safety

- a) **Keep work area clean and well lit.** Cluttered or dark areas invite accidents.
- b) **Do not operate power tools in explosive atmospheres, such as in the presence of flammable liquids, gases or dust.** Power tools create sparks which may ignite the dust or fumes.
- c) **Keep children and bystanders away while operating a power tool.** Distractions can cause you to lose control.

#### 5.1.2 Electrical safety

- a) **Power tool plugs must match the outlet. Never modify the plug in any way. Do not use any adapter plugs with earthed (grounded) power tools.** Unmodified plugs and matching outlets will reduce risk of electric shock.
- b) **Avoid body contact with earthed or grounded surfaces such as pipes, radiators, ranges and refrigerators.** There is an increased risk of electric shock if your body is earthed or grounded.
- c) **Do not expose power tools to rain or wet conditions.** Water entering a power tool will increase the risk of electric shock.
- d) **Do not abuse the cord. Never use the cord for carrying, pulling or unplugging the power tool. Keep cord away from heat, oil, sharp edges or moving parts.** Damaged or entangled cords increase the risk of electric shock.
- e) **When operating a power tool outdoors, use an extension cord suitable for outdoor use.** Use of a cord suitable for outdoor use reduces the risk of electric shock.
- f) **If operating a power tool in a damp location is unavoidable, use a residual current device (RCD) protected supply.** Use of an RCD reduces the risk of electric shock.

#### 5.1.3 Personal safety

- a) **Stay alert, watch what you are doing and use common sense when operating a power tool. Do not use a power tool while you are tired or under**

**the influence of drugs, alcohol or medication.** A moment of inattention while operating power tools may result in serious personal injury.

- b) **Use personal protective equipment. Always wear eye protection.** Protective equipment such as dust mask, non-skid safety shoes, hard hat, or hearing protection used for appropriate conditions will reduce personal injuries.
- c) **Prevent unintentional starting. Ensure the switch is in the off-position before connecting to power source and/or battery pack, picking up or carrying the tool.** Carrying power tools with your finger on the switch or energising power tools that have the switch on invites accidents.
- d) **Remove any adjusting key or wrench before turning the power tool on.** A wrench or a key left attached to a rotating part of the power tool may result in personal injury.
- e) **Do not overreach. Keep proper footing and balance at all times.** This enables better control of the power tool in unexpected situations.
- f) **Dress properly. Do not wear loose clothing or jewellery. Keep your hair, clothing and gloves away from moving parts.** Loose clothes, jewellery or long hair can be caught in moving parts.
- g) **If devices are provided for the connection of dust extraction and collection facilities, ensure these are connected and properly used.** Use of dust collection can reduce dust-related hazards.

#### 5.1.4 Power tool use and care

- a) **Do not force the power tool. Use the correct power tool for your application.** The correct power tool will do the job better and safer at the rate for which it was designed.
- b) **Do not use the power tool if the switch does not turn it on and off.** Any power tool that cannot be controlled with the switch is dangerous and must be repaired.
- c) **Disconnect the plug from the power source and/or the battery pack from the power tool before making any adjustments, changing accessories, or storing power tools.** Such preventive safety measures reduce the risk of starting the power tool accidentally.
- d) **Store idle power tools out of the reach of children and do not allow persons unfamiliar with the power tool or these instructions to operate the power tool.** Power tools are dangerous in the hands of untrained users.
- e) **Maintain power tools. Check for misalignment or binding of moving parts, breakage of parts and any other condition that may affect the power tool's operation. If damaged, have the power tool repaired before use.** Many accidents are caused by poorly maintained power tools.
- f) **Keep cutting tools sharp and clean.** Properly maintained cutting tools with sharp cutting edges are less likely to bind and are easier to control.

- g) **Use the power tool, accessories and tool bits etc. in accordance with these instructions taking into account the working conditions and the work to be performed.** Use of the power tool for operations different from those intended could result in a hazardous situation.

#### 5.1.5 Service

- a) **Have your power tool serviced by a qualified repair person using only identical replacement parts.** This will ensure that the safety of the power tool is maintained.

#### 5.2 Safety warnings common for grinding, sanding, wire brushing, polishing or abrasive cutting-off operations

- a) **This power tool is intended to function as a grinder, sander, wire brush or cut-off tool. Read all safety warnings, instructions, illustrations and specifications provided with this power tool.** Failure to follow all instructions listed below may result in electric shock, fire and/or serious injury.
- b) **Operations such polishing are not recommended to be performed with this power tool** Operations for which the power tool was not designed may create a hazard and cause personal injury.
- c) **Do not use accessories which are not specifically designed and recommended by the tool manufacturer.** Just because the accessory can be attached to your power tool, it does not assure safe operation.
- d) **The rated speed of the accessory must be at least equal to the maximum speed marked on the power tool.** Accessories running faster than their rated speed can break and fly apart.
- e) **The outside diameter and the thickness of your accessory must be within the capacity rating of your power tool.** Incorrectly sized accessories cannot be adequately guarded or controlled.
- f) **Threaded mounting of accessories must match the grinder spindle thread. For accessories mounted by flanges, the arbour hole of the accessory must fit the locating diameter of the flange.** Accessories that do not match the mounting hardware of the power tool will run out of balance, vibrate excessively and may cause loss of control.
- g) **Do not use a damaged accessory. Before each use inspect the accessory such as abrasive wheels for chips and cracks, backing pad for cracks, tear or excess wear, wire brush for loose or cracked wires. If power tool or accessory is dropped, inspect for damage or install an undamaged accessory. After inspecting and installing an accessory, position yourself and bystanders away from the plane of the rotating accessory and run the power tool at maximum no-load speed for one minute.** Damaged accessories will normally break apart during this test time.
- h) **Wear personal protective equipment. Depending on application, use face shield, safety goggles or safety glasses. As appropriate, wear dust mask, hearing protectors, gloves and workshop apron**

**capable of stopping small abrasive or workpiece fragments. The eye protection must be capable of stopping flying debris generated by various operations.** The eye protection must be capable of stopping flying debris generated by various operations. The dust mask or respirator must be capable of filtering particles generated by your operation. Prolonged exposure to high intensity noise may cause hearing loss.

- i) **Keep bystanders a safe distance away from work area. Anyone entering the work area must wear personal protective equipment.** Fragments of workpiece or of a broken accessory may fly away and cause injury beyond immediate area of operation.
- j) **Hold the power tool by insulated gripping surfaces only, when performing an operation where the cutting accessory may contact hidden wiring or its own cord.** Cutting accessory contacting a "live" wire may make exposed metal parts of the power tool "live" and could give the operator an electric shock.
- k) **Position the cord clear of the spinning accessory.** If you lose control, the cord may be cut or snagged and your hand or arm may be pulled into the spinning accessory.
- l) **Never lay the power tool down until the accessory has come to a complete stop.** The spinning accessory may grab the surface and pull the power tool out of your control.
- m) **Do not run the power tool while carrying it at your side.** Accidental contact with the spinning accessory could snag your clothing, pulling the accessory into your body.
- n) **Regularly clean the power tool's air vents.** The motor's fan will draw the dust inside the housing and excessive accumulation of powdered metal may cause electrical hazards.
- o) **Do not operate the power tool near flammable materials.** Sparks could ignite these materials.
- p) **Do not use accessories that require liquid coolants.** Using water or other liquid coolants may result in electrocution or shock.

#### 5.3 Kickback and related warnings

Kickback is a sudden reaction to a pinched or snagged rotating wheel, backing pad, brush or any other accessory. Pinching or snagging causes rapid stalling of the rotating accessory which in turn causes the uncontrolled power tool to be forced in the direction opposite of the accessory's rotation at the point of the binding.

For example, if an abrasive wheel is snagged or pinched by the workpiece, the edge of the wheel that is entering into the pinch point can dig into the surface of the material causing the wheel to climb out or kick out. The wheel may either jump toward or away from the operator, depending on direction of the wheel's movement at the point of pinching. Abrasive wheels may also break under these conditions.

Kickback is the result of power tool misuse and/or incorrect operating procedures or conditions and can be avoided by taking proper precautions as given below.

- a) **Maintain a firm grip on the power tool and position your body and arm to allow you to resist kickback forces. Always use auxiliary handle, if provided, for maximum control over kickback or torque reaction during start-up.** The operator can control torque reactions or kickback forces, if proper precautions are taken.
- b) **Never place your hand near the rotating accessory.** Accessory may kickback over your hand.
- c) **Do not position your body in the area where power tool will move if kickback occurs.** Kickback will propel the tool in direction opposite to the wheel's movement at the point of snagging.
- d) **Use special care when working corners, sharp edges etc. Avoid bouncing and snagging the accessory.** Corners, sharp edges or bouncing have a tendency to snag the rotating accessory and cause loss of control or kickback.
- e) **Do not attach a saw chain woodcarving blade or toothed saw blade.** Such blades create frequent kickback and loss of control.

#### 5.4 Safety warnings specific for grinding and abrasive cutting-off operations

- a) **Use only wheel types that are recommended for your power tool and the specific guard designed for the selected wheel.** Wheels for which the power tool was not designed cannot be adequately guarded and are unsafe.
- b) **The grinding surface of centre depressed wheels must be mounted below the plane of the guard lip.** An improperly mounted wheel that projects through the plane of the guard lip cannot be adequately protected.
- c) **The guard must be securely attached to the power tool and positioned for maximum safety, so the least amount of wheel is exposed towards the operator.** The guard helps to protect operator from broken wheel fragments, accidental contact with wheel and sparks that could ignite clothing.
- d) **Wheels must be used only for recommended applications. For example: do not grind with the side of cut-off wheel.** Abrasive cut-off wheels are intended for peripheral grinding, side forces applied to these wheels may cause them to shatter.
- e) **Always use undamaged wheel flanges that are of correct size and shape for your selected wheel.** Proper wheel flanges support the wheel thus reducing the possibility of wheel breakage. Flanges for cut-off wheels may be different from grinding wheel flanges.
- f) **Do not use worn down wheels from larger power tools.** Wheel intended for larger power tool is not suitable for the higher speed of a smaller tool and may burst.

#### 5.5 Additional safety warnings specific for abrasive cutting-off operations

- a) **Do not "jam" the cut-off wheel or apply excessive pressure. Do not attempt to make an excessive depth of cut.** Overstressing the wheel increases the

loading and susceptibility to twisting or binding of the wheel in the cut and the possibility of kickback or wheel breakage.

- b) **Do not position your body in line with and behind the rotating wheel.** When the wheel, at the point of operation, is moving away from your body, the possible kickback may propel the spinning wheel and the power tool directly at you.
- c) **When wheel is binding or when interrupting a cut for any reason, switch off the power tool and hold the power tool motionless until the wheel comes to a complete stop. Never attempt to remove the cut-off wheel from the cut while the wheel is in motion otherwise kickback may occur.** Investigate and take corrective action to eliminate the cause of wheel binding.
- d) **Do not restart the cutting operation in the workpiece. Let the wheel reach full speed and carefully re-enter the cut.** The wheel may bind, walk up or kickback if the power tool is restarted in the workpiece.
- e) **Support panels or any oversized workpiece to minimize the risk of wheel pinching and kickback.** Large workpieces tend to sag under their own weight. Supports must be placed under the workpiece near the line of cut and near the edge of the workpiece on both sides of the wheel.
- f) **Use extra caution when making a "pocket cut" into existing walls or other blind areas.** The protruding wheel may cut gas or water pipes, electrical wiring or objects that can cause kickback.

#### 5.6 Safety warnings specific for wire brushing operations

- a) **Be aware that wire bristles are thrown by the brush even during ordinary operation. Do not overstress the wires by applying excessive load to the brush.** The wire bristles can easily penetrate light clothing and/or skin.
- b) **If the use of a guard is recommended for wire brushing, do not allow any interference of the wire wheel or brush with the guard.** Wire wheel or brush may expand in diameter due to work load and centrifugal forces.

#### 5.7 Additional safety rules

##### 5.7.1 Personal safety

- a) **Breathing protection must be worn if the power tool is used without a dust removal system for work that creates dust.**
- b) **Improve the blood circulation in your fingers by relaxing your hands and exercising your fingers during breaks between working.**
- c) **Avoid touching rotating parts. Switch the power tool on only after bringing it into position at the workpiece.** Touching rotating parts, especially rotating drill bits, discs or blades, etc. may lead to injury.
- d) **Always lead the supply cord and extension cord away from the power tool to the rear while work-**

ing. This helps to avoid tripping over the cord while working.

- e) **When grinding with straight grinding discs and cutting with cutting discs in metalworking applications, use the guard with cover plate.**
- f) **Always hold the power tool securely with both hands on the grips provided. Keep the grips dry, clean and free from oil and grease.**

### 5.7.2 Power tool use and care

- a) **Grinding discs must be stored and handled carefully in accordance with the manufacturer's instructions.**
- b) **Check that the grinding disc is fitted in accordance with the manufacturer's instructions.**
- c) **If use of a spacer ring or other intermediate part is specified and the part is supplied with the grinding disc, check to ensure that the part is fitted.**
- d) **Never use the power tool without the guard.**
- e) **The workpiece must be fixed securely in place.**
- f) **After disc breakage, or if the power tool is dropped, falls or suffers other mechanical damage, it must be checked at a Hilti Service Center.**
- g) **Before use, check that the cutting or grinding disc has been fitted correctly and the clamping nut tightened. Then allow the power tool to run for 30 seconds under no load while holding it securely. Switch off the power tool immediately if significant vibration or any other faults are noticed. Should this occur, examine the power tool in order to determine the cause.**
- h) **Do not use cutting discs for grinding.**
- i) **Do not use type 27 grinding discs with integrated clamping nut.**
- j) **Take steps to ensure that flying sparks from the power tool do not present a hazard, i.e. by striking yourself or other persons. Adjust the position of the guard accordingly.**
- k) **Children must be instructed not to play with the power tool.**
- l) **The power tool is not intended for use by children, by debilitated persons or those who have received no instruction or training.**
- m) **Do not use the power tool if it starts with a jolt. This may be an indication that the electronic control unit is defective. Have the tool repaired at an authorized Hilti service center right away.**
- n) **WARNING: Some dust created by grinding, sanding, cutting and drilling contains chemicals known to cause cancer, birth defects, infertility or other reproductive harm; or serious and permanent respiratory or other injury. Some examples of these chemicals are: lead from lead-based paints, crystalline silica from bricks, concrete and other masonry products and natural stone, arsenic and chromium from chemically-treated lumber. Your risk from these exposures varies, depending on how often you do this type of work. To reduce exposure to these chemicals, the operator and bystanders should work in a well-ventilated area, work with approved safety equipment, such as respiratory pro-**

**tection appropriate for the type of dust generated, and designed to filter out microscopic particles and direct dust away from the face and body. Avoid prolonged contact with dust. Wear protective clothing and wash exposed areas with soap and water.** Allowing dust to get into your mouth, eyes, or to remain on your skin may promote absorption of harmful chemicals.

### 5.7.3 Electrical safety



- a) **Before beginning work, check the working area (e.g. using a metal detector) to ensure that no concealed electric cables or gas and water pipes are present.** External metal parts of the power tool may become live, for example, when an electric cable is damaged accidentally. This presents a serious risk of electric shock.
- b) **Check the power tool's supply cord at regular intervals and have it replaced by a qualified specialist if found to be damaged. If the power tool's supply cord is damaged it must be replaced with a specially-prepared supply cord available from Hilti Customer Service. Check extension cords at regular intervals and replace them if found to be damaged. Do not touch the supply cord or extension cord if it is damaged while working. Disconnect the supply cord plug from the power outlet. Damaged supply cords or extension cords present a risk of electric shock.**
- c) **Dirty or dusty power tools which have been used frequently for work on conductive materials should be checked at regular intervals at a Hilti Service Center. Under unfavorable circumstances, dampness or dust adhering to the surface of the power tool, especially dust from conductive materials, may present a risk of electric shock.**
- d) **When working outdoors with an electric tool check to ensure that the tool is connected to the electric supply by way of a ground fault circuit interrupter (GFCI) with a rating of max. 30 mA (tripping current). Use of a ground fault circuit interrupter reduces the risk of electric shock.**
- e) **Use of a ground fault circuit interrupter (GFCI) with a maximum tripping current of 30 mA is recommended.**

### 5.7.4 Work area

- a) **Ensure that the workplace is well lit.**
- b) **Ensure that the workplace is well ventilated. Exposure to dust at a poorly ventilated workplace may result in damage to the health.**

### 5.7.5 Personal protective equipment



The user and any other persons in the vicinity must wear ANSI Z87.1-approved eye protection, a hard

hat, ear protection, protective gloves and breathing protection while the power tool is in use.

en

## 6 Before use



### CAUTION

Wear gloves when fitting or removing parts, when making adjustments or when remedying malfunctions.

### WARNING

Never use the power tool without the guard.

### CAUTION

Before using another accessory that is recommended for the angle grinder in conjunction with the angle grinders mentioned above, read the operating instructions for the applicable angle grinder and observe all instructions.

### 6.1 Fitting the side handle

#### WARNING

The side handle must be fitted for all types of work.

The side handle may be screwed onto the power tool on the right or left.

### 6.2 Guard

#### CAUTION

Adjust the position of the guard to suit the requirements of the work being done.

#### CAUTION

The closed side of the guard must always face the operator.

### 6.2.1 Fitting the guard or guard with cover plate 7

#### NOTE

The guard is equipped with locating lugs that ensure only guards of a type suitable for use with the power tool can be fitted. The locating lugs of the guard fit into the guard mount on the power tool.

1. Fit the guard onto the drive spindle collar so that the two triangular marks on the guard and on the power tool in alignment.
2. Press the guard onto the drive spindle collar; press the guard release button and then rotate the guard until it engages and the guard release button jumps back to its outset position.

### 6.2.2 Adjusting the guard 8

1. Press the guard release button and then rotate the guard until it engages in the desired position.

### 6.2.3 Removing the guard or guard with cover plate

1. Press the guard release button and then rotate the guard until the triangular marks on the guard and the power tool are in alignment.
2. Lift off the guard.

### 6.2.4 Fitting and removing the front cover 9

1. Press the front cover onto the standard guard, with the closed side positioned as shown in the illustration, until it engages.
2. To remove the front cover, release the catch and then pull the front cover away from the standard guard.

### 6.3 Fitting and removing the disc 10 11

#### CAUTION

Wear gloves when fitting or removing parts, when making adjustments or when remedying malfunctions.

#### DANGER

Check that the speed rating printed on the cutting or grinding disc is equal to or higher than the rated speed of the power tool.

#### DANGER

Check the condition of the grinding disc before using it. Do not use discs that are broken, cracked or damaged in any way.

## NOTE

Diamond discs must be replaced when the cutting or grinding performance drops significantly. This generally is the case when the segments reach a height of less than 1/16". Other discs must be replaced when the cutting performance drops significantly or other parts of the angle grinder (not the disc) come into contact with the material you are working on. Abrasive discs generally have to be replaced when the durability date has been reached.

1. Clean the clamping flange.
2. Fit the clamping flange onto the drive spindle.
3. Fit the insert tool.
4. Screw on the clamping nut corresponding to the type of disc fitted **11**.
5. **CAUTION Do not press the spindle lockbutton before the drive spindle has stopped rotating.** Press the spindle lockbutton and hold it in this position.
6. Use the wrench to tighten the clamping nut securely and then release the spindle lockbutton.
7. To remove the disc from the power tool, follow the instructions for fitting the disc but carry out the steps in the reverse order.

## 6.4 Fitting and removing accessories (e.g. discs, brushes) with integrated thread

1. Screw the accessory onto the drive spindle.
2. **CAUTION Do not press the spindle lockbutton before the drive spindle has stopped rotating.** Press the spindle lockbutton and hold it in this position.
3. Use the open-end wrench to tighten the accessory securely and then release the spindle lockbutton.
4. To remove this, follow the instructions for fitting the module but carry out the steps in the reverse order.

## 6.5 Rotating the gearing section **12**

### NOTE

To allow the power tool to be used safely and without fatigue in all positions (e.g. on / off switch facing upwards), the gearing section can be rotated to one of four positions at 90° intervals.

1. Disconnect the supply cord plug from the power outlet.
2. Clean the power tool.
3. Remove the side handle from the power tool.
4. Remove the four screws from the gearing section.
5. Rotate the gearing section to the desired position without pulling it away from the power tool.
6. Secure the gearing section by inserting and tightening the four screws.
7. Fit the side handle.

## 7 Operation



### NOTE

Adjust the position of the guard to suit the requirements of the work being done.

### DANGER

**Wear ear protectors.** Exposure to noise can cause hearing loss.

### WARNING

**Test new cutting or grinding discs by allowing them to run at maximum speed in a protected area for at least 60 seconds.**

### WARNING

Slits cut in loadbearing walls of buildings or other structures may influence the statics of the structure, especially when steel reinforcing bars or load-bearing components are cut through. **Consult the structural engineer, architect, or person in charge of the building project before beginning the work.**

### WARNING

**The electric supply voltage must comply with the information given on the type identification plate on the power tool.**

### WARNING

**Always use the side handle with the power tool.**

### WARNING

**Never use the power tool without the guard.**

### CAUTION

**Use clamps or a vice to hold the workpiece securely.**

### WARNING

Cutting or grinding may cause splintering of the material. **Wear eye protection.**

### DANGER

**The operator and bystanders must wear breathing protection if the work causes dust.**

### WARNING

**Avoid touching rotating parts. Switch the power tool on only after bringing it into position at the workpiece.**



Touching rotating parts, especially rotating drill bits, discs or blades, etc. may lead to injury.

#### CAUTION

The insert tool may get hot during use. **Wear protective gloves when changing insert tools.**

#### WARNING

**Reduce the load on the power tool by avoiding tilting the disc in the kerf when cutting.** The disc may otherwise break, or the power tool may kick back or stall.

#### CAUTION

**Improve the blood circulation in your fingers by relaxing your hands and exercising your fingers during breaks between working.**

#### WARNING

**Keep inflammable materials away from the working area.**

#### CAUTION

In accordance with the applications for which it is designed, the power tool produces a high torque. **Always use the side handle and hold the power tool with both hands.** The user must be prepared for sudden sticking and stalling of the insert tool.

#### CAUTION

Working on the material may cause it to splinter. **Wear eye protection and protective gloves. Wear breathing**

**protection if no dust removal system is used.** Splintering material presents a risk of injury to the eyes and body.

### 7.1 Rough grinding

#### CAUTION

**Never use abrasive cutting discs for grinding.**

Best results are obtained when the disc maintains an angle of 5° to 30° with the working surface when grinding. Move the power tool to and fro while applying moderate pressure. This will avoid overheating and discoloration of the workpiece and ensure an even surface finish.

### 7.2 Cutting

When cutting, apply moderate feed pressure and do not tilt the power tool or, respectively, the cutting disc (hold at approx. 90° to the surface being cut). For best results, start cutting at the smallest cross section when cutting profiles and square tube.

### 7.3 Hold-to-run switch

The hold-to-run switch with built-in safety interlock enables the user to check the switch function and prevents inadvertent starting of the power tool.

1. Press the safety release to unlock the hold-to-run switch and then press the switch fully.
2. When the hold-to-run switch is released, the safety interlock returns automatically to the locked position.

## 8 Care and maintenance

#### CAUTION

**Disconnect the mains plug from the power outlet.**

### 8.1 Care of the power tool

#### DANGER

Under extreme conditions, when used for working on metal, conductive dust may accumulate inside the tool. This may have an adverse effect on the tool's protective insulation. **Under such conditions, the tool should be plugged into a ground fault circuit interrupter (GFCI) and use of a stationary dust removal system and frequent cleaning of the tool's cooling air slots is recommended.**

The outer casing of the power tool is made from impact-resistant plastic. Sections of the grip are made from a synthetic rubber material.

Never operate the power tool when the air vents are blocked. Regularly clean the power tool's air vents carefully with a dry brush. Do not permit foreign objects to enter the interior of the tool. The motor's fan will draw dust into the casing and an excessive accumulation of conductive dust (e.g. metal, carbon fiber) may cause electrical hazards. Clean the outside of the power tool at regular intervals with a slightly damp cloth. Do not use a spray, steam pressure cleaning equipment or running

water for cleaning. This may negatively affect the electrical safety of the tool. Always keep the grip surfaces of the tool free from oil and grease. Do not use cleaning agents which contain silicone.

#### NOTE

Frequent work on conductive materials (e.g. metal, carbon fiber) may make shorter maintenance intervals necessary. Take your individual work place risk assessment into account.

### 8.2 Maintenance

#### WARNING

**Do not operate the power tool if parts are damaged or when the controls do not function faultlessly. Have the power tool repaired by Hilti Service.**

#### WARNING

**Repairs to the electrical section of the power tool may be carried out only by trained electrical specialists.**

Check all external parts of the power tool for damage at regular intervals and check that all controls operate faultlessly.

### 8.3 Checking the power tool after care and maintenance

After carrying out care and maintenance work on the power tool, check that all protective and safety devices are fitted and that they function faultlessly.

en

## 9 Troubleshooting

Fault	Possible cause	Remedy
The power tool doesn't start.	Interruption in the electric supply.	Plug in another electric appliance and check whether it works.
	The supply cord or plug is defective.	Have it checked by a trained electrical specialist and replaced if necessary.
	The carbon brushes are worn.	Have it checked by a trained electrical specialist and replaced if necessary.
The power tool doesn't achieve full power.	The extension cord's conductor cross section is inadequate.	Use an extension cord with an adequate conductor cross section.

## 10 Disposal



Most of the materials from which Hilti power tools or appliances are manufactured can be recycled. The materials must be correctly separated before they can be recycled. In many countries, Hilti has already made arrangements for taking back your old power tools or appliances for recycling. Please ask your Hilti customer service department or Hilti representative for further information.

## 11 Manufacturer's warranty - tools

Hilti warrants that the tool supplied is free of defects in material and workmanship. This warranty is valid so long as the tool is operated and handled correctly, cleaned and serviced properly and in accordance with the Hilti Operating Instructions, and the technical system is maintained. This means that only original Hilti consumables, components and spare parts may be used in the tool.

This warranty provides the free-of-charge repair or replacement of defective parts only over the entire lifespan of the tool. Parts requiring repair or replacement as a result of normal wear and tear are not covered by this warranty.

**Additional claims are excluded, unless stringent national rules prohibit such exclusion. In particular, Hilti is not obligated for direct, indirect, incidental or consequential damages, losses or expenses in connection with, or by reason of, the use of, or inability to use the tool for any purpose. Implied warranties of merchantability or fitness for a particular purpose are specifically excluded.**

For repair or replacement, send the tool or related parts immediately upon discovery of the defect to the address of the local Hilti marketing organization provided.

This constitutes Hilti's entire obligation with regard to warranty and supersedes all prior or contemporaneous comments and oral or written agreements concerning warranties.



Hilti Corporation

LI-9494 Schaan

Tel.: +423 / 234 21 11

Fax: +423 / 234 29 65

[www.hilti.com](http://www.hilti.com)

1 609 92A 0JE

Hilti = registered trademark of Hilti Corp., Schaan

W 3200 | 1213 | 00-Pos. 3 | 1

Printed in Germany © 2013

Right of technical and programme changes reserved S. E. & O.

382623 / A2



382623