

I.

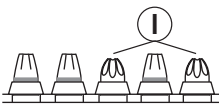

Geräteservice durchführen wenn:

- I. Kartuschenfehlzündungen oder
- II. Leistungsschwankungen auftreten.

Apporter votre appareil à réviser:

- I. en cas de ratés de cartouches ou
- II. en cas de variations de la puissance d'implantation.

II.

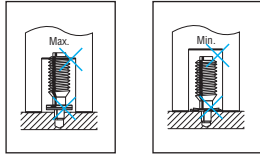

Service tool whenever:

- I. a cartridge misfires or
- II. inconsistent driving power occurs.

Hacer el servicio del aparato en caso de:

- I. fallos en el encendido de los cartuchos
- II. oscilaciones de la potencia.

Demontage / Disassembly / Demontage / Demontaje

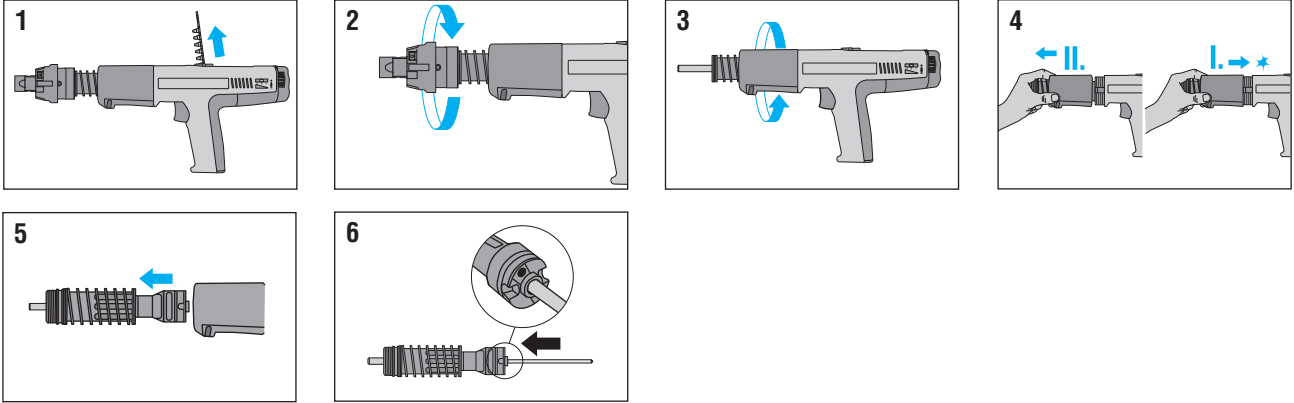

Prüfen / Check / Contrôle / Control

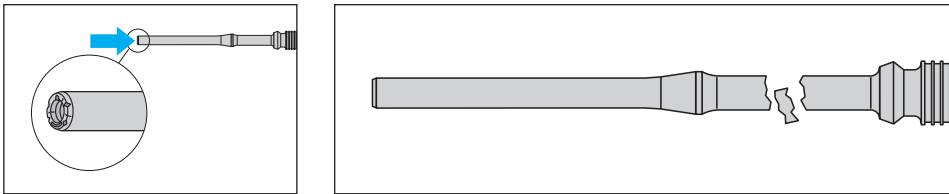

Reinigung / Cleaning / Nettoyage / Limpieza

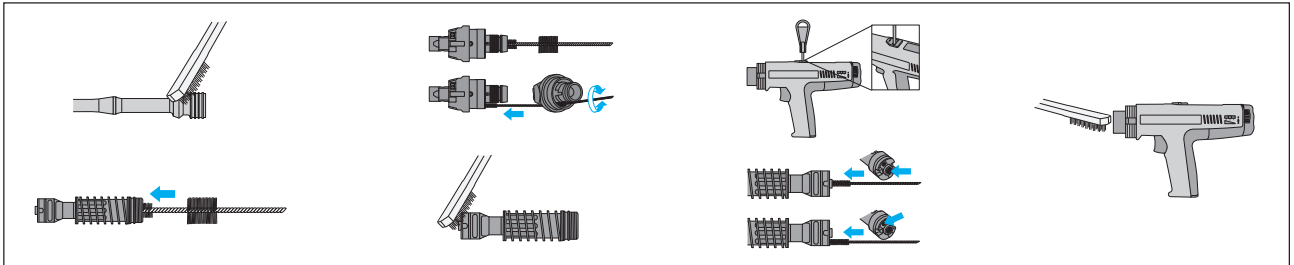

Montage / Assembly / Assemblage / Montaje

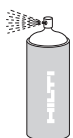
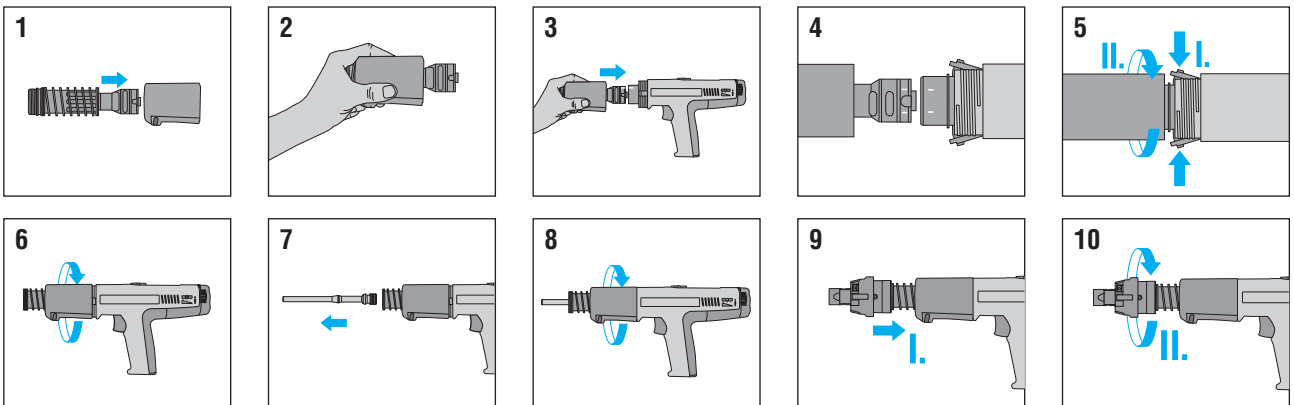

Reinigen Sie Ihre Geräte regelmässig mit Hilti Spray!
Clean your tools regularly with Hilti spray!
Nettoyer régulièrement vos appareils avec du lubrifiant Hilti en spray!
Limpie sus herramientas regularmente con el spray Hilti!

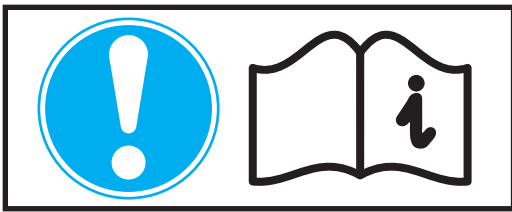

Montageanleitung / Installation Instructions / Instructions d'installation / Instrucciones de instalación

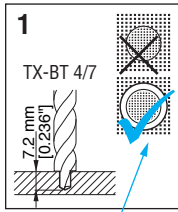

Sichtbarer Ring
Visible ring
Cercle visible
Aro visible

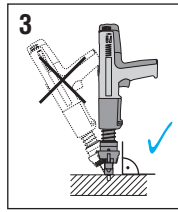
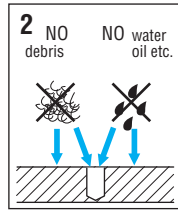

Trec 8 Nm (5.9 ft/lbs)

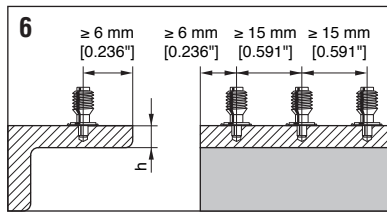
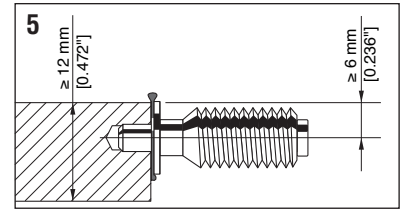
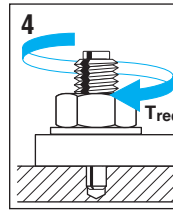

For grating applications use the centering device,
X-BT CD 18/24 #378885
Für Gitterrostanwendungen verwenden Sie die Zentrierhilfe,
X-BT CD 18/24 #378885
Pour applications sur callebotis utilisez le centreur de maille,
X-BT CD 18/24 #378885
Para aplicaciones sobre rejillas industriales use el centrador,
X-BT CD 18/24 #378885

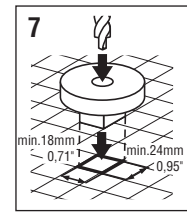

Leistungseinstellung / Power Regulation / Réglage du puissance / Ajustar la potencia

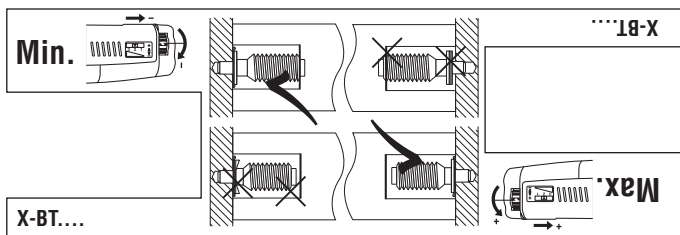

Leistungsregulierungslehre verwenden
Use Power Regulation Guide
Utiliser guide de réglage du puissance
Usar guía para ajustar la potencia

