

# HILTI

## SF 2H-A

Deutsch	de
English	en
Nederlands	nl
Français	fr
Español	es
Português	pt
Italiano	it
Polski	pl
Česky	cs
Slovenčina	sk
Magyar	hu
Slovenščina	sl
Hrvatski	hr
Русский	ru
Български	bg
Română	ro
Ελληνικά	el

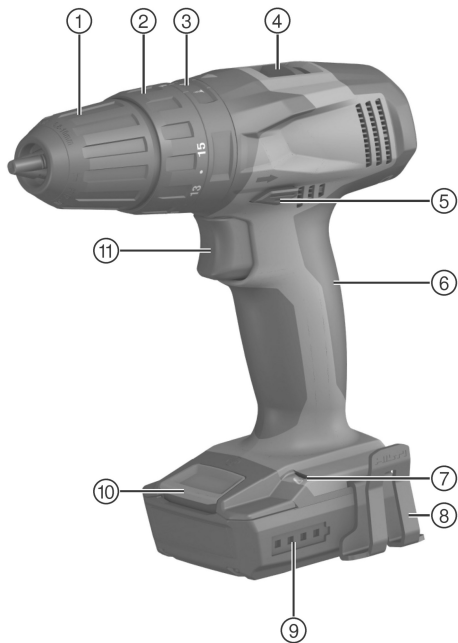

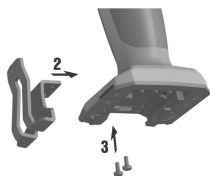
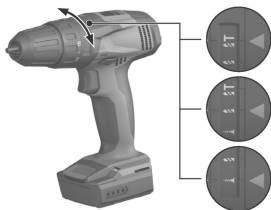
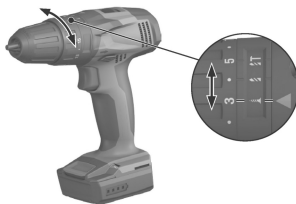

**2****3****4****5**

6

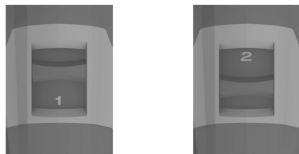

7

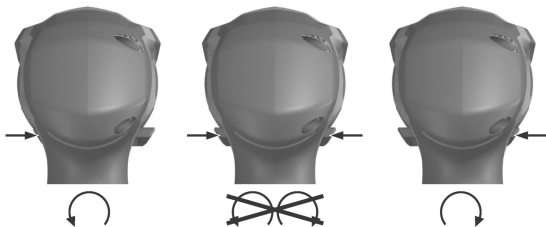

# SF 2H-A

de	Original-Bedienungsanleitung .....	1
en	Original operating instructions .....	18
nl	Oorspronkelijke handleiding .....	33
fr	Mode d'emploi original .....	50
es	Manual de instrucciones original .....	67
pt	Manual de instruções original .....	84
it	Istruzioni originali .....	101
pl	Oryginalna instrukcja obsługi .....	118
cs	Originální návod k obsluze .....	135
sk	Originálny návod na obsluhu .....	150
hu	Eredeti használati utasítás .....	166
sl	Originalna navodila za uporabo .....	183
hr	Originalne upute za uporabu .....	199
ru	Оригинальное руководство по эксплуатации .....	215
bg	Оригинално Ръководство за експлоатация .....	234
ro	Manual de utilizare original .....	252
el	Μετάφραση οδηγιών χρήσης από το πρωτότυπο .....	269

## 1 Information about the documentation

### 1.1 Conventions







#### 1.1.1 Warning signs

The following warning signs are used:

	General warning
--	-----------------

#### 1.1.2 Symbols

The following symbols are used:

	Read the operating instructions before use.
	Instructions for use and other useful information
$n_0$	Rated speed under no load
/min	Revolutions per minute
	Direct current (DC)
	Screwdriving
	Drilling without hammering
	Drilling with hammering action (hammer drilling)

#### 1.1.3 Typographical emphasis

The following typographical features are used to emphasize important passages in the technical documentation about your drill/driver:

<b>1</b>	These numbers refer to the corresponding illustrations.
----------	---

### 1.2 About this documentation

- ▶ Read these operating instructions before the product is used or operated for the first time. This is a prerequisite for safe, trouble-free handling and use of the product.
- ▶ Observe the safety instructions and warnings printed in this documentation and on the tool.
- ▶ Always keep the operating instructions with the tool and make sure that the operating instructions are with the tool when it is given to other persons.

### 1.3 Product information

The type designation can be found on the type identification plate at the base of the tool and the serial number on the side of the casing.

- ▶ Make a note of this data in the following table and always refer to it when making an enquiry to your Hilti representative or Hilti Service Center.

## Product information

Type:	
Generation:	01
Serial no.:	

## 2 Safety

### 2.1 Warnings

#### The purpose of warnings

Warnings alert persons to hazards that occur when handling or using the product.

#### Description of the key words used



#### **DANGER**

Draws attention to imminent danger that will lead to serious personal injury or fatality.



#### **WARNING**

Draws attention to a potentially dangerous situation that could lead to serious personal injury or fatality.



#### **CAUTION**

Draws attention to a potentially dangerous situation that could lead to slight personal injury or damage to the equipment or other property.

### 2.2 Safety instructions

The safety rules given in the following section contain all general safety rules for electric tools which, in accordance with the applicable standards, require to be listed in the operating instructions. Accordingly, some of the rules listed may not be relevant to this electric tool.

#### 2.2.1 General power tool safety warnings

##### WARNING

**Read all safety warnings and all instructions.** Failure to follow the warnings and instructions may result in electric shock, fire and/or serious injury.

**Save all warnings and instructions for future reference.**

The term “power tool” in the warnings refers to your mains-operated (corded) power tool or battery-operated (cordless) power tool.

##### **Work area safety**

- ▶ **Keep work area clean and well lit.** Cluttered or dark areas invite accidents.
- ▶ **Do not operate power tools in explosive atmospheres, such as in the presence of flammable liquids, gases or dust.** Power tools create sparks which may ignite the dust or fumes.
- ▶ **Keep children and bystanders away while operating a power tool.** Distractions can cause you to lose control.

## Electrical safety

- ▶ **Power tool plugs must match the outlet. Never modify the plug in any way. Do not use any adapter plugs with earthed (grounded) power tools.** Unmodified plugs and matching outlets will reduce risk of electric shock.
- ▶ **Avoid body contact with earthed or grounded surfaces, such as pipes, radiators, ranges and refrigerators.** There is an increased risk of electric shock if your body is earthed or grounded.
- ▶ **Do not expose power tools to rain or wet conditions.** Water entering a power tool will increase the risk of electric shock.
- ▶ **Do not abuse the cord. Never use the cord for carrying, pulling or unplugging the power tool. Keep cord away from heat, oil, sharp edges or moving parts.** Damaged or entangled cords increase the risk of electric shock.
- ▶ **When operating a power tool outdoors, use an extension cord suitable for outdoor use.** Use of a cord suitable for outdoor use reduces the risk of electric shock.
- ▶ **If operating a power tool in a damp location is unavoidable, use a residual current device (RCD) protected supply.** Use of an RCD reduces the risk of electric shock.

## Personal safety

- ▶ **Stay alert, watch what you are doing and use common sense when operating a power tool. Do not use a power tool while you are tired or under the influence of drugs, alcohol or medication.** A moment of inattention while operating power tools may result in serious personal injury.
- ▶ **Use personal protective equipment. Always wear eye protection.** Protective equipment such as dust mask, non-skid safety shoes, hard hat, or hearing protection used for appropriate conditions will reduce personal injuries.
- ▶ **Prevent unintentional starting. Ensure the switch is in the off-position before connecting to power source and/or battery pack, picking up or carrying the tool.** Carrying power tools with your finger on the switch or energising power tools that have the switch on invites accidents.
- ▶ **Remove any adjusting key or wrench before turning the power tool on.** A wrench or a key left attached to a rotating part of the power tool may result in personal injury.
- ▶ **Do not overreach. Keep proper footing and balance at all times.** This enables better control of the power tool in unexpected situations.
- ▶ **Dress properly. Do not wear loose clothing or jewellery. Keep your hair, clothing and gloves away from moving parts.** Loose clothes, jewellery or long hair can be caught in moving parts.



- ▶ **If devices are provided for the connection of dust extraction and collection facilities, ensure these are connected and properly used.** Use of dust collection can reduce dust-related hazards.

#### **Power tool use and care**

- ▶ Do not force the power tool. Use the correct power tool for your application. The correct power tool will do the job better and safer at the rate for which it was designed.
- ▶ **Do not use the power tool if the switch does not turn it on and off.** Any power tool that cannot be controlled with the switch is dangerous and must be repaired.
- ▶ **Disconnect the plug from the power source and/or the battery pack from the power tool before making any adjustments, changing accessories, or storing power tools.** Such preventive safety measures reduce the risk of starting the power tool accidentally.
- ▶ **Store idle power tools out of the reach of children and do not allow persons unfamiliar with the power tool or these instructions to operate the power tool.** Power tools are dangerous in the hands of untrained users.
- ▶ **Maintain power tools. Check for misalignment or binding of moving parts, breakage of parts and any other condition that may affect the power tool's operation. If damaged, have the power tool repaired before use.** Many accidents are caused by poorly maintained power tools.
- ▶ **Keep cutting tools sharp and clean.** Properly maintained cutting tools with sharp cutting edges are less likely to bind and are easier to control.
- ▶ **Use the power tool, accessories and tool bits etc. in accordance with these instructions, taking into account the working conditions and the work to be performed.** Use of the power tool for operations different from those intended could result in a hazardous situation.

#### **Battery tool use and care**

- ▶ **Recharge only with the charger specified by the manufacturer.** A charger that is suitable for one type of battery pack may create a risk of fire when used with another battery pack.
- ▶ **Use power tools only with specifically designated battery packs.** Use of any other battery packs may create a risk of injury and fire.
- ▶ **When battery pack is not in use, keep it away from other metal objects, like paper clips, coins, keys, nails, screws or other small metal objects, that can make a connection from one terminal to another.** Shorting the battery terminals together may cause burns or a fire.
- ▶ **Under abusive conditions, liquid may be ejected from the battery; avoid contact. If contact accidentally occurs, flush with water. If liquid contacts eyes, additionally seek medical help.** Liquid ejected from the battery may cause irritation or burns.

## Service

- ▶ **Have your power tool serviced by a qualified repair person using only identical replacement parts.** This will ensure that the safety of the power tool is maintained.

### 2.2.2 Drill safety warnings

- ▶ **Use auxiliary handle(s), if supplied with the tool.** Loss of control can cause personal injury.
- ▶ **Hold power tool by insulated gripping surfaces, when performing an operation where the cutting accessory may contact hidden wiring.** Cutting accessory contacting a "live" wire may expose metal parts of the power tool "live" and could give the operator an electric shock.

### 2.2.3 Drill/driver safety warnings

- ▶ **Hold power tool by insulated gripping surfaces, when performing an operation where the fastener may contact hidden wiring.** Fasteners contacting a "live" wire may make exposed metal parts of the power tool "live" and could give the operator an electric shock.

### 2.2.4 Additional safety instructions

#### Personal safety

- ▶ **Tampering with or modification of the tool is not permitted.**
- ▶ **Keep the grips dry, clean and free from oil and grease.**
- ▶ **Improve the blood circulation in your fingers by relaxing your hands and exercising your fingers during breaks between working.**
- ▶ **Do not look directly into the light source (LEDs) integrated in the drill/driver and do not direct the light at other persons' faces.** This presents a risk of dazzling or eye damage.
- ▶ **Avoid touching rotating parts. Switch the power tool on only after bringing it into position at the workpiece.** Touching rotating parts, especially rotating drill bits or other accessory tools, may lead to injury.
- ▶ **Wear protective gloves.** The drill/driver may get hot during use. There is a risk of injury (cutting or burning) if the accessory tool is touched while changing it.
- ▶ **Activate the safety lock (forward/reverse selector switch in the middle position) when changing bits or batteries and before storage or transportation of the power tool.**
- ▶ **The power tool is not intended for use by debilitated persons who have received no special training. Keep the power tool out of reach of children.**
- ▶ **Dust from materials, such as paint containing lead, some wood species, concrete / masonry / stone containing silica, and minerals as well as metal, may be harmful. Contact with or inhalation of the dust may cause allergic reactions and/or respiratory or other diseases to the operator**

or bystanders. Certain kinds of dust are classified as carcinogenic such as oak and beech dust, especially in conjunction with additives for wood conditioning (chromate, wood preservative). Material containing asbestos may be handled only by specialists. **Use a dust removal system whenever possible. To achieve a high level of dust collection, use a suitable vacuum cleaner. When indicated, wear a respirator appropriate for the type of dust generated. Ensure that the workplace is well ventilated. Follow national requirements for the materials you want to work with.**

- ▶ **Before beginning the work, check the hazard classification of the dust that will be produced. Use an industrial vacuum cleaner with an officially approved protection classification in compliance with locally applicable dust protection regulations.**
- ▶ Working on the material may cause it to splinter. **Wear eye protection.** Flying fragments present a risk of injury to the body and eyes.
- ▶ **Always hold the tool securely by the grip.** If the accessory tool (e.g. the drill bit) sticks and stalls, the power tool, due to its high torque, may tend to rotate about its own axis in the direction opposite to that of the accessory tool.

#### **Use and care of electric tools**

- ▶ **Secure the workpiece. Use clamps or a vice to hold the workpiece in position.** The workpiece is thus held more securely than by hand and both hands remain free to operate the power tool.
- ▶ **Check that the accessory tools used are compatible with the chuck system and that they are secured in the chuck correctly.**

#### **Use and care of battery-powered tools**

- ▶ **Check that the tool is switched off before inserting the battery.** Inserting a battery into an electric tool that is switched on can lead to accidents.
- ▶ **Do not expose batteries to high temperatures and keep them away from fire.** There is a risk of explosion.
- ▶ **Do not disassemble, squash or incinerate batteries and do not subject them to temperatures over 80°C.** This presents a risk of fire, explosion or injury through contact with caustic substances.
- ▶ **Avoid ingress of moisture.** Ingress of moisture may cause a short circuit, resulting in burning injuries or fire.
- ▶ **Observe the special guidelines applicable to the transport, storage and use of Li-ion batteries.**
- ▶ **Avoid short circuiting the battery terminals. Check that the battery terminals and the terminals in the power tool are free from foreign objects before inserting the battery in the tool.** Short circuiting the battery terminals presents a risk of fire, explosion and chemical burns.

- ▶ **Do not continue to use or attempt to charge damaged batteries (e.g. batteries with cracks, broken parts, bent or pushed-in / pulled-out contacts).**
- ▶ If the battery is too hot to touch it may be defective. **In this case, place the power tool in a non-flammable location, well away from flammable materials, where it can be kept under observation and allowed to cool down. Contact Hilti Service after the battery has cooled down.**

### Electrical safety

- ▶ **Before beginning work, check the working area (e.g. using a metal detector) to ensure that no concealed electric cables or gas and water pipes are present.** External metal parts of the power tool may become live, for example, when an electric cable is damaged accidentally. This presents a serious risk of electric shock.

## 3 Description

### 3.1 Overview of the product 1

- |   |  |
|---|--|
| ① Chuck (keyless chuck)   | ⑥ Grip   |
| ② Torque setting ring   | ⑦ LED light                                      |
| ③ Function setting ring (screwdriving/drilling/hammer drilling) | ⑧ Belt hook (optional)                           |
| ④ Gear selector switch  | ⑨ Battery charge status display                  |
| ⑤ Forward/reverse selector switch with safety lock              | ⑩ Battery release button                         |
|   | ⑪ Control switch (with electronic speed control) |

### 3.2 Intended use

The product described is a hand-held, cordless hammer drill/driver for driving and removing screws, drilling in steel, wood and plastic and for hammer drilling in masonry.

**Hilti** products are designed for professional use and may be operated, serviced and maintained only by trained, authorized personnel. This personnel must be informed of any particular hazards that may be encountered. The hammer drill/driver and its ancillary equipment may present hazards when used incorrectly by untrained personnel or when used not as directed.

- ▶ Do not use the battery as a power source for other unspecified appliances.
- ▶ Observe the national health and safety requirements.
- ▶ To reduce the risk of injury, use only genuine **Hilti** tools and accessories.

- To power the hammer drill/driver, use a rechargeable battery of a type approved by **Hilti** and a charger from the C4/12 series.

**Note**

Make sure that the outer surfaces of the battery are clean and dry before inserting the battery in an approved battery charger. Read the operating instructions for the charger for further information about the charging procedure.

### 3.3 Charge status display

The charge status of the Li-ion battery is displayed after pressing the release button.

Status	Meaning
4 LEDs light.	• Charge status: 75 % to 100 %
3 LEDs light.	• Charge status: 50 % to 75 %
2 LEDs light.	• Charge status: 25 % to 50 %
1 LED lights.	• Charge status: 10 % to 25 %
1 LED blinks.	• Charge status: < 10 %

**Note**

Battery charge status cannot be displayed while the control switch is pressed.

### 3.4 Overload and overheating protection

The power tool is equipped with an electronic system to protect against overloading and overheating. The power tool switches itself off automatically in the event of overloading or overheating. After releasing the control switch, the power tool may not restart immediately when the switch is pressed again (while the power tool is cooling down).

**Note**

Overloading or overheating are not indicated by the charge status display.

### 3.5 Items supplied

Hammer drill/driver, operating instructions.

**Note**

To help ensure safe and reliable operation, use only genuine Hilti spare parts and consumables. Spare parts, consumables and accessories approved by us for use with the product can be found at your local **Hilti** Center or online at: [www.hilti.com](http://www.hilti.com)

## 4 Technical data

### 4.1 Hammer drill/driver

<b>Rated voltage</b>	10.8 V	
<b>Weight in accordance with EPTA procedure 01/2003</b>	1.2 kg	
<b>Speed</b>	<b>1st gear</b>	0 rpm ... 400 rpm
	<b>2nd gear</b>	0 rpm ... 1,500 rpm
<b>Torque (soft joint) <math>\ddagger</math></b>	$\leq 12$ Nm	
<b>Torque range (15 settings) <math>\ddagger</math></b>	0.5 Nm ... 3.5 Nm	
<b>Keyless chuck clamping range</b>	0.8 mm ... 10 mm	
<b><math>\varnothing</math> drill bit (softwood)</b>	0.8 mm ... 14 mm	
<b><math>\varnothing</math> drill bit (hardwood)</b>	0.8 mm ... 10 mm	
<b><math>\varnothing</math> drill bit (metal)</b>	0.8 mm ... 6 mm	

### 4.2 Noise information and vibration values determined in accordance with EN 60745

The sound pressure and vibration values given in these instructions have been measured in accordance with a standardized test and may be used to compare one electric tool with another. They may be used for a preliminary assessment of exposure.

The data given represents the main applications of the electric tool. However, if the electric tool is used for different applications, with different accessory tools, or is poorly maintained, the data may vary. This may significantly increase exposure over the total working period.

An accurate estimation of exposure should also take into account the times when the power tool is switched off, or when it is running but not actually being used for a job. This may significantly reduce exposure over the total working period.

Identify additional safety measures to protect the operator from the effects of noise and/or vibration, for example: maintaining the power tool and accessory tools, keeping the hands warm, organization of work patterns.

#### Noise emission values determined in accordance with EN 60745

	<b>SF 2H-A</b>
<b>Emission sound pressure level (<math>L_{pA}</math>)</b>	85 dB(A)
<b>Uncertainty for the sound pressure level (<math>K_{pA}</math>)</b>	3 dB(A)
<b>Sound (power) level (<math>L_{WA}</math>)</b>	96 dB(A)
<b>Uncertainty for the sound power level (<math>K_{WA}</math>)</b>	3 dB(A)

Total vibration (vector sum of three directions), measured in accordance with EN 60745

	<b>SF 2H-A</b>
Vibration emission value for screwdriving ( $a_h$ )	0.5 m/s <sup>2</sup>
Uncertainty for screwdriving (K)	1.5 m/s <sup>2</sup>
Vibration emission value for drilling in metal ( $a_{h, D}$ )	0.5 m/s <sup>2</sup>
Uncertainty for drilling in metal (K)	1.5 m/s <sup>2</sup>

### 4.3 Battery

	<b>B 12/2.6 Li-Ion</b>
Rated voltage	10.8 V
Capacity	2.6 Ah
Energy capacity	28.08 Wh
Weight	0.24 kg

## 5 Operation

### 5.1 Inserting the battery 2



#### CAUTION

**Risk of injury.** The drill/driver may start inadvertently.

- ▶ Before fitting the battery, check that the drill/driver is switched off and that the switch safety lock is activated.



#### CAUTION

**Electrical hazard.** Dirty contacts may cause a short circuit.

- ▶ Before inserting the battery, check to ensure that the battery terminals and the contacts in the drill/driver are free from foreign objects.



#### CAUTION

**Risk of injury.** If the battery is not fitted correctly it may drop out and fall.

- ▶ Check that the battery is securely seated in the tool so that it cannot drop out and fall, thereby presenting a hazard to other persons.

- ▶ Fit the battery and make sure that it is heard to engage.

### 5.2 Fitting the belt hook (optional) 3



#### WARNING

**Risk of injury.** A falling power tool may present a risk of injury to yourself and others.

- ▶ Check that the belt hook is fitted securely before beginning work.



### Note

The belt hook allows the power tool to be attached to a belt worn by the operator. The belt hook can be fitted to allow attachment on the left or right side of the body.

- ▶ Fit the belt hook.

## 5.3 Selecting the function 4

- ▶ Select the desired function.

## 5.4 Setting the torque 5

- ▶ Set the desired torque.



### Note

The torque is limited only when the power tool is set to screwdriving mode 1.

## 5.5 Selecting the gear 6



### Note

The gear selector switch can be operated only when the motor is not running.

- ▶ Select the gear.

## 5.6 Setting forward or reverse rotation 7



### Note

An interlock prevents switching while the motor is running. The control switch is locked when the forward/reverse switch is in the middle position (safety lock).

- ▶ Set the forward/reverse switch to the desired direction of rotation.

## 5.7 Switching on

- ▶ Press the control switch.
  - ◁ Speed of rotation is regulated by the distance the control switch is pressed in.

## 5.8 Switching off

- ▶ Release the control switch.

## 5.9 Fitting the accessory tool

1. Set the forward/reverse switch to the middle position or remove the battery from the power tool.
2. Open the keyless chuck.



3. Insert the accessory tool in the chuck and then turn the keyless chuck firmly until tight.
4. Check that the accessory tool is held securely.

### 5.10 Removing the accessory tool

1. Set the forward/reverse switch to the middle position or remove the battery from the power tool.
2. Open the keyless chuck.
3. Pull the accessory tool out of the chuck.

### 5.11 Screwdriving

1. Set the function selector ring to the “screwdriving” position .
2. Set the torque setting ring to the desired torque.
3. Set the forward/reverse switch to the desired direction of rotation.

### 5.12 Drilling

1. Set the function selector ring to the “drilling” position .
2. Set the forward/reverse switch to the “forward” position.

### 5.13 Hammer drilling

1. Set the function selector ring to the “hammer drilling” position .
2. Set the forward/reverse switch to the “forward” position.

## 6 Care, maintenance, transport and storage

### 6.1 Care and maintenance of the tool



#### WARNING

**Electrical hazards.** Improper repairs to electrical parts may lead to serious injuries.

- ▶ Electrical parts may be repaired only by trained electrical specialists.

- ▶ Keep the tool, especially its grip surfaces, clean and free from oil and grease. Do not use cleaning agents containing silicone.
- ▶ Never operate the power tool when the ventilation slots are blocked. Clean the air vents carefully using a dry brush. Do not permit foreign objects to enter the interior of the tool.
- ▶ Clean the outer surfaces of the tool with a slightly damp cloth at regular intervals.

### 6.2 Care of Li-ion batteries

- ▶ Keep the battery clean and free from oil and grease.
- ▶ Clean the outer surfaces of the tool with a slightly damp cloth at regular intervals. Do not use cleaning agents containing silicone.

- ▶ To achieve maximum battery life, stop drawing power from the battery as soon as a significant drop in the performance of the power tool is noticed.
- ▶ Charge the batteries using the **Hilti** chargers approved for use with Li-ion batteries.

### 6.3 Transport and storage



#### **WARNING**

**Fire hazard.** Risk of short circuiting.

- ▶ Never store or transport Li-ion batteries in loose, bulk form.

- ▶ Remove the battery before transporting or storing the hammer drill/driver.
- ▶ Observe the nationally and internationally applicable transport regulations when shipping batteries by road, rail, sea or air.



#### **Note**

Ideally, the battery should be stored in a fully-charged state in a dry place that is as cool as possible. Storing the battery in places subject to high ambient temperatures (e.g. at a window) has an adverse effect on battery life and increases the rate of self-discharge.

If the battery no longer reaches full charge, it may have lost capacity due to aging or overstressing. It is still possible to work with this battery. You should, however, soon replace the battery with a new one.

## 7 Troubleshooting

If the trouble you are experiencing is not listed in this table or you are unable to remedy the problem by yourself, please contact **Hilti** Service.

Trouble or fault	Possible cause	Action to be taken
The power tool doesn't run.	The battery is not fully inserted.	▶ Push the battery in until it engages with an audible click.
	Low battery.	▶ Charge the battery.
The control switch can't be pressed, i.e. the switch is locked.	The forward/reverse selector switch is in the middle position.	▶ Push the forward/reverse switch to the left or right.
The battery runs down more quickly than usual.	Very low ambient temperature.	▶ Allow the battery to warm up slowly to room temperature.

Trouble or fault	Possible cause	Action to be taken
The battery doesn't engage with an audible click.	The retaining lugs on the battery are dirty.	▶ Clean the retaining lug and push the battery in until it engages. Contact <b>Hilti</b> Service if the problem persists.
The power tool or the battery becomes very warm.	Electrical fault.	▶ Switch the power tool off immediately, remove the battery, keep it under observation, allow it to cool down and contact <b>Hilti</b> Service.
	The tool is overloaded (application limits exceeded).	▶ Select a suitable power tool for the application.

## 8 Disposal



### WARNING

**Risk of injury.** Hazards presented by improper disposal.

- ▶ Improper disposal of the equipment may have the following consequences: The burning of plastic components generates toxic fumes which may present a health hazard. Batteries may explode if damaged or exposed to very high temperatures, causing poisoning, burns, acid burns or environmental pollution. Careless disposal may permit unauthorized and improper use of the equipment. This may result in serious personal injury, injury to third parties and pollution of the environment.
- ▶ Dispose of defective batteries right away. Keep them out of reach of children. Do not disassemble or incinerate the batteries.
- ▶ Batteries that have reached the end of their life must be disposed of in accordance with national regulations or returned to **Hilti**.



Most of the materials from which **Hilti** tools and appliances are manufactured can be recycled. The materials must be correctly separated before they can be recycled. In many countries, your old tools, machines or appliances can be returned to **Hilti** for recycling. Ask **Hilti** Service or your Hilti representative for further information.

In accordance with the European Directive on waste electrical and electronic equipment and its implementation in conformance with national law, electric tools or appliances that have reached the end of their life must be collected separately and returned to an environmentally compatible recycling facility.



- Disposal of electric tools or appliances together with household waste is not permissible.

## 9 Manufacturer's warranty

- Please contact your local **Hilti** representative if you have questions about the warranty conditions.

## 10 EC declaration of conformity

### Manufacturer

Hilti Aktiengesellschaft  
Feldkircherstrasse 100  
9494 Schaan  
**Liechtenstein**

We declare, on our sole responsibility, that this product complies with the following directives and standards.

Designation Drill/driver

Type designation SF 2H-A

Generation 01

Year of design 2015

Applicable directives:

- 2014/30/EU (as of April 20, 2016)
- 2006/42/EC
- 2006/66/EC
- 2011/65/EU

Applicable standards:

- EN 60745-1, EN 60745-2-1, EN 60745-2-2
- EN ISO 12100

Technical documentation filed at:

- Electric Tools Approval Department  
Hilti Entwicklungsgesellschaft mbH  
Hiltistraße 6  
86916 Kaufering  
**Germany**

Schaan, 09.2015

Paolo Luccini  
(Head of BA Quality and Process  
Management / Business Unit Elec-  
tric Tools & Accessories)

Tassilo Deinzer  
(Executive Vice President / Business  
Unit Power Tools & Accessories)

# HILTI

Hilti Corporation

LI-9494 Schaan

Tel.: +423/234 21 11

Fax: +423/234 29 65

[www.hilti.com](http://www.hilti.com)

